



**sigmax**

- R19 -

User Manual

# Contents

<b>Introduction</b>	<b>3</b>
Warranty	3
Conformity	7
Specifications	8
IDEX / FFF Technology	9
Safety	9
Safety Signage	11
<b>Setting Up Your Printer</b>	<b>12</b>
Unboxing	12
Contents	13
Set up	14
<b>Getting started</b>	<b>21</b>
Setup Assistant	21
Mirror and Duplication modes	24
Installing shims	26
First Printing	28
<b>Starting Out With BCN3D Cura</b>	<b>29</b>
Your first dual print	29
First Mirror/Duplication print	33
<b>Firmware Upgrade</b>	<b>34</b>
<b>Functionalities</b>	<b>36</b>
<b>Operation and maintenance</b>	<b>38</b>
Change hotend	38
Clean and lubricate axes	44
Hotend cleaning	48
<b>Filament</b>	<b>50</b>
<b>Maintenance Plan</b>	<b>53</b>
<b>BCN3D Technologies Technical Assistance Services</b>	<b>54</b>
<b>Diagram Of The Sigmax R19</b>	<b>55</b>
<b>Terms And Conditions</b>	<b>57</b>
<b>Open Source</b>	<b>59</b>

# Introduction

## Warranty

---

Fundació Privada Center CIM ("Fundació CIM") provides this Warranty to the consumers of the BCN3D brand products included in the sales package ("Product").

This Warranty will be valid only in the country in which the sale of the Products has been made. Fundació CIM hereby guarantee that, within the warranty period, Fundació CIM or an authorized service company will correct, within a reasonable period of time, the defects of materials or manufacturing detected in the Products, according to the clauses set out below.

All the products purchased at BCN3D Technologies are covered by the **Law 23/2003** of July 10 of Warranties on the Sale of Consumer Goods (consolidated in Royal Legislative Decree 1/2007). Also covered by the **Directive 99/44 /CE** of the European Parliament and of the Council of 25 May 1999 on certain aspects of the sale and warranties of consumer goods, as amended by the Directive **2011/83/UE** of the European Parliament European Parliament and the Council of 25 October 2011 on the rights of consumers.

The products acquired to integrate them in a productive or commercial process, will have a warranty period of not less than six months as provided in the **articles 1484 to 1491 of the Civil Code** for hidden defects or defects.

## Product Warranty Period

As previously stated, all products purchased directly from BCN3D Technologies will have a 24-month warranty for all those purchases made within the European Union, and 12 months for the rest of the countries. The warranty will come into force from the date on which the product was purchased for the first time by the end customer (invoice date). If you do not have the purchase invoice, the manufacturing date of the product registered by BCN3D Technologies will be considered as the beginning of the warranty period.

### Technical Support

For any questions or problems with BCN3D Products, please contact us at:

c/ Esteve Terrades, 1  
Edifici RDIT del PMT, 2a Planta, oficina 212  
08860 Castelldefels, Barcelona (Espanya)  
email: support@bcn3dtechnologies.com  
Tel: +34 934 137088

---

Fundació Privada Centre CIM  
c/ Llorens i Artigas, 12  
08028 Barcelona (Espanya)  
Tel. +34 934017171  
CIF: G63749162

### List of Consumable components

This document lists the Consumable components that, due to their natural deterioration, are excluded from the Warranty: **Hotends, Teflon Tube, Glass printing surface, Filament Spools, Glue Stick, Printed Parts, Calibration Gauges, Shims, Lubrication Kit.**

# Warranty

---

## Conditions to exercise the warranty

The BCN3D warranty is granted under the following conditions:

- 1** Acquire the product through BCN3D Technologies or one of its authorized resellers (See <https://www.bcn3dtechnologies.com/en/reseller/> to see the addresses of authorized BCN3D Distributors).
- 2** Be within the established deadlines, which are:
  - **2 years** from the invoice date for purchases within the EU.
  - **1 year** from the invoice date for purchases outside the EU.
- 3** The product must be packed in its original packaging. Otherwise, BCN3D Technologies reserves the right to accept or reject the return, or if it is estimated, a depreciation of the product.
- 4** The product has been sold as new, not as reconditioned or used.
- 5** The serial number of the product to be returned will have to correspond to the one in the BCN3D Technologies records.
- 6** Unless specifically requested by BCN3D Technologies, nothing else should be sent apart from the Product. All accessories and removable storage devices such as SD memory cards must be removed from the product. BCN3D Technologies is not responsible for the loss, damage or destruction of accessories or removable storage devices, unless caused intentionally or negligently by BCN3D Technologies.
- 7** Customers are allowed to use third-party materials, accessories, etc, since that does not cancel the warranty. As long as the use of these elements does not cause damage to the Product, the part (s) affected by this damage will be excluded from the warranty.

**8** If a part of the Product is repaired or replaced during the warranty period, the remaining warranty period for the entire product will apply to this part. However, repairing and / or replacing a part will not extend the warranty period.

BCN3D Technologies official Distributors are responsible for the warranty on behalf of BCN3D Technologies. Therefore, any warranty notification must be made directly to the BCN3D Technologies official Distributor where the product was originally purchased.

Any warranty claim must first be acknowledged and accepted, either by BCN3D Technologies or by a Distributor of BCN3D Technologies. The Distributor is obliged to rectify any damage for free according to this guarantee. In the event that the defect can not be repaired, the Distributor, within the warranty period, will replace the Product for an identical product, or if the product is no longer manufactured, for a similar product of the same value or offer an adequate refund.

Depending on the country, the warranty may not automatically include the costs incurred for the shipping of the defective Products for repair or replacement.

## How to exercise the warranty?

In order to exercise the warranty, you will have to contact us to [support@bcn3dtechnologies.com](mailto:support@bcn3dtechnologies.com).

- 1** You will receive a document by email to be completed (RMA), so that we can authorize the reparation.
- 2** Once the RMA is completed, you must send it to [support@bcn3dtechnologies.com](mailto:support@bcn3dtechnologies.com) duly completed.
- 3** The technical support department will assess the situation and within 48 hours will tell you whether or not we accept your return request. If accepted, it will assign you an RMA number with a validity of 30 days.

# Warranty

---

- 4** The product must be sealed in its **original packaging**. In the case of not returning the order in its original and sealed packaging, BCN3D Technologies reserves the right to accept or reject the return or establish a depreciation of the product.
- 5** Once the product has been packed, we will send a transporter that will pick up the goods to be returned perfectly packed, being able to desist from the collection in case of improper packing. It is important that you place the **RMA number visible on the package**.
- 6** Once the goods are received in our facilities, our technical service will inspect them and determine whether the product is covered by warranty or not.
- 7** If the user does not accept the reparation, BCN3D Technologies will return the product by the agreed method of RMA. If the user does not collect the product, or if it can not be sent to the address provided by the user, BCN3D Technologies will contact the user by the means that he considers convenient and previously provided. If the user does not collect the product during the 90 days following the moment of sending the information, BCN3D Technologies reserves the right to invoice the cost of storage, disposal of the product according to the applicable laws and regulations, and any law for non-payment .
- 3** The damages caused by the non-compliance of the maintenance plan exposed in the User's Manual of the Product.
- 4** The malfunctions or damages caused by modifications, alterations or repairs carried out by any individual or company not authorized by Fundació CIM, being excluded from this assumption the replacements of consumables.
- 5** Damages caused by unusual failures in the electrical network.
- 6** Damage caused by abuse, misuse, accident or negligence when using the Product.
- 7** Effects derived from the Product's exposure to floods, fire, humidity, spillage of food or chemical compounds, corrosion, oxidation, extreme atmospheric conditions or any other agent external to the Product.
- 8** Damages derived from the use of Software other than that recommended by BCN3D Technologies.
- 9** Damages caused by not using materials recommended by BCN3D Technologies.
- 10** The components considered as Consumables, listed in the attached document.
- 11** Any product in which the serial number is not visible.

## Warranty exclusions

This Warranty does not cover:

- 1** Defects caused by inappropriate transportation (without original packaging) or handling of the Product (including without limitation, defects caused by sharp elements, cutting, bending, compression or fall).
- 2** The wear and tear caused by the use of the Product, including, but not limited to, the wear of moving parts, control panels or elements that interact with the operation of the Product.

# Warranty

---

## Limitations and liability exemptions

This Warranty is the sole and exclusive Warranty of Fundació CIM and the sole and exclusive responsibility of Fundació CIM for the defects present in its Products. Therefore, this Warranty replaces any other guarantee issued by Fundació CIM, whether oral or written on any method.

However, this Warranty does not limit either the consumer's rights, specified in current legislation, or the rights against the seller, also set out in the legislation.

Fundació CIM is not responsible in any case for the loss of business, loss of contracts, loss of profits, loss of savings, increase of costs or expenses for the use of its Products. In the same way, Fundació CIM rejects the responsibility of any indirect, accidental or collateral damage caused by the use of its Products.

# Conformity

---

The CIM Private Foundation Centre declares that the Sigmax R19 printer complies with the essential requirements and any other applicable or mandatory provisions of the Directives.

It complies with the essential requirements of the European Directives:



**2006/42/EEC** Machinery Directive

**2006/95/EEC** Low Voltage Directive

**2004/108/EEC** Electromagnetic Compatibility Directive (EMC)

**2011/65/EU** Restrictions on the use of hazardous substances in electrical and electronic equipment (RoHS)

The Sigmax R19 printer has been manufactured in compliance with the following harmonised standards, and consequently conforms to the essential requirements established by the Directives:

**2006/42/EEC** UNE-EN ISO 12100:2012; UNE-EN ISO 13732-1 :2008; EN ISO 7010:2012

**2006/95/EEC** UNE-EN 60204-1; UNE-EN 60947-3:2009

**2004/108/EEC** UNE-EN 55022:2011; UNE-EN 55024:2011; UNE-EN 61000-4-3-2:2007

Changes / modifications not approved by the responsible party could void the user's authority to operate the equipment.

This equipment has been tested and found to comply with the limits for a Class B digital device, pursuant to part 15 of the FCC Rules. These limits are designed to provide reasonable protection against harmful interference in a residential installation. This equipment generates, uses and can radiate radio frequency energy and, if not installed and used in accordance with the instructions, may cause harmful interference to radio communications.

However, there is no guarantee that interference will not occur in a particular installation. If this equipment does cause harmful interference to radio or television reception, which can be determined by turning the equipment off and on, the user is encouraged to try to correct the interference by one or more of the following measures:

- Reorient or relocate the receiving antenna.
- Increase the separation between the equipment and receiver.
- Connect the equipment into an outlet on a circuit different from that to which the receiver is connected.
- Consult the dealer or an experienced radio/TV technician for help.

REI-RAEE: 6107



Fundació Privada Centre CIM  
Llorens i Artigas, 12 08028 Barcelona.

Tel: +34 934017171

[www.fundaciocim.org](http://www.fundaciocim.org)

# Specifications

---

Manufacturing technology	Fused Filament Fabrication (FFF)
Architecture	Independent dual extruder (IDEX)
General dimensions	685 mm x 440 mm x 680 mm (fully assembled)
Weight	20 kg (without filament spools)
Printing volume	420 x 297 x 210 mm
Number of extruders	2
Nozzle diameter	0.3 / 0.4 / 0.5 Special / 0.6 Standard / 0.8 / 1mm
Layer height	0.05-0.5 mm (depending on the nozzle diameter)
Positioning resolution	Axis X: 0.0125 mm Axis Y: 0.0125 mm Axis Z: 0.001 mm
Operating temperature	15 °C - 35 °C
Maximum extruder temperature	290 °C
Maximum printing surface temperature	100 °C
Filament diameter	2.85 ± 0.05 mm
Compatible material	PLA / ABS / Nylon / PET-G / TPU / PVA / Composites / Others
Electronics	BCN3D Electronics
Connectivity	SD card (autonomous operation), USB
Firmware	BCN3D Sigmax - Marlin
Operating sound	50 dBA
Compatible files	gcode
Software preparation files	Recommended: BCN3D Cura Compatible: Slic3r, Simplify3D,...
Power supply	AC 84–240 V, AC 3.6-1.3A, 50–60 Hz
Electrical energy consumption	370W



## IDEX / FFF technology

---

The Sigmax R19 is a 3D printer which uses fused filament fabrication (FFF) technology, which manufactures objects by depositing molten material in a series of layers. Objects are created using a digital model of the object, which is sliced into thin layers. When printing the extruder print head moves along the axis to deposit the material for one layer at a time, before moving slightly upwards to begin printing a new layer. This process is repeated until the object has been completed.

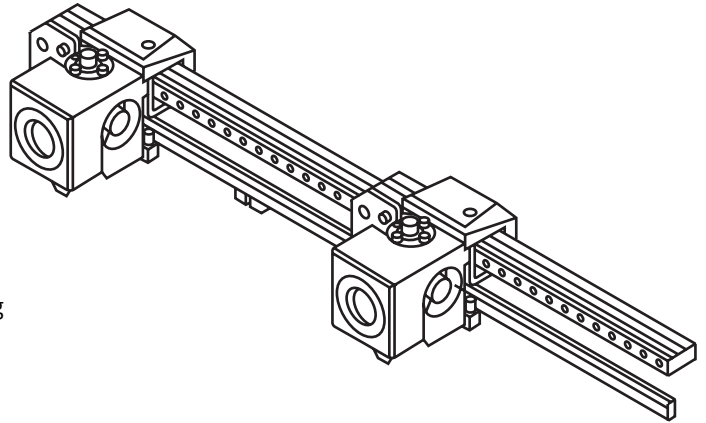

Since FFF technology requires deposit material on top of plastic previously extruded, certain complex geometries with overhangs require additional support structures to be successfully printed. However, printing supports with the same material of the model can result in many post-processing problems.

The Independent Dual Extruder System (IDEX) is BCN3D's unique approach to avoid this issue and also offers a bunch of new key features. The two extruders are controlled independently, so that when one extruder is not being used it can be kept away from the printing area to prevent the plastic from oozing onto the object and spoiling the final result.

Having two independent extruders offer the user the ability to print, not only with soluble supports, but also multi-material objects, print in two different colors or even combine different nozzle sizes to get more resistant parts or cut down the printing process.

## Safety

---

To avoid potential residual risks the user should read and understand the following safety measures (you are strongly advised to read this before using the machine).

To highlight the areas where extra care should be taken, safety alert stickers have been affixed to the relevant parts of the machine to warn the user of potential hazards.

Any modifications made to the machine without the manufacturer's approval will invalidate the product's Declaration of Conformity (CE) and warranty.

Consequently, the Fundació CIM and BCN3D Technologies ARE EXEMPT FROM ANY LIABILITY IF THE USER DOES NOT FOLLOW THE INSTRUCTIONS FOR USE:



**Very important. As with any other appliance, do not touch the terminals of the mains, the switch, or the power supply. There is a risk of electrocution. The other cables of the machine operate at 24V and there is no risk whatsoever.**

**Connect the machine to an electrical outlet according to the current legislation.**

**Do not connect or disconnect any device and/or electrical connector when the machine is connected to the power supply.**

**Keep all of your body and all objects away from the moving parts of the machine when they are moving.**

**Do not touch the hot parts (heated bed and hot-ends) when the machine is switched on, and wait 15 minutes after it has been switched off before touching them.**

**Handle the glass printing surface with care. Make sure it is not dropped or hit with anything as this could seriously damage it.**

**The printing materials are not innocuous and emit toxic fumes. Always print in open or well-ventilated spaces and use a protective mask.**

**Do not breathe closer than 25 cm from the tool head when printing.**

**Supervise the printer while it is printing to make sure it is working properly.**

**In the event of emergency, stop the machine immediately by pressing the switch, and disconnect the power supply.**

**This device is not a toy. It should only be used by minors under 16 under the supervision of an adult.**

**The spatula is a dangerous tool that can cause injuries. Use it only to remove plastic rests when running the calibration assistant.**

# Safety signage

The following stickers have been affixed to the printer to warn users about the hazardous areas of the machine, and actions which are not recommended as they will stop the machine from working properly.

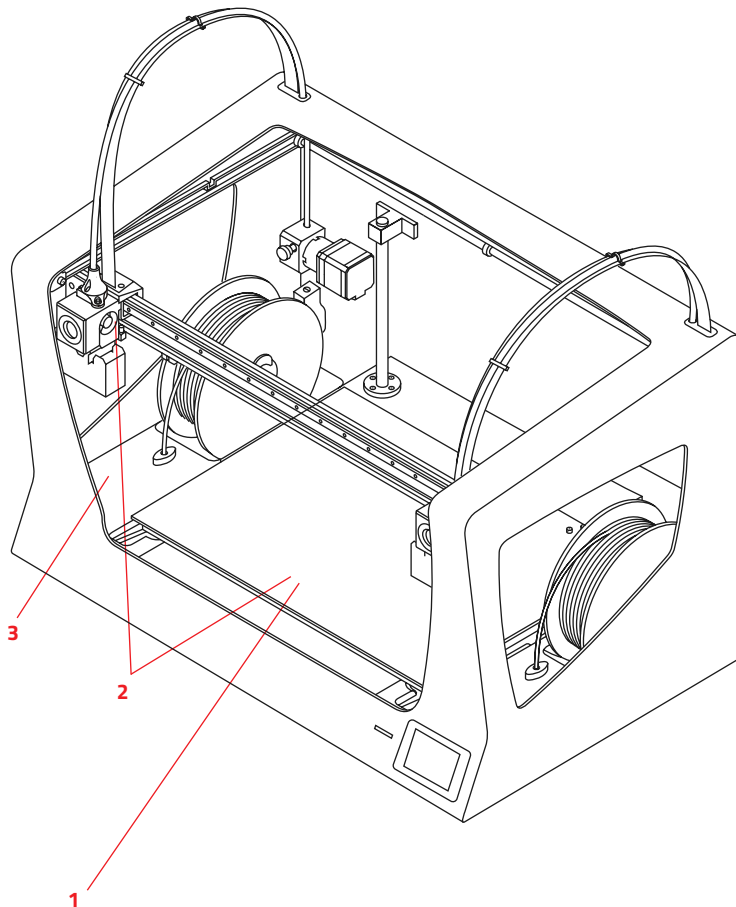

1 Pictogram: Danger. Hot surface.



2 Pictogram: Danger. Will cause burns.



3 Pictogram: Risk of trapped hand/ finger.



# Setting up your printer

## Unboxing

---

The Sigmoid R19 is delivered in a well-secured cardboard box which measures 675mm x 440mm x 680mm. We recommend you to follow the steps below in order to unpack your 3D printer correctly:

1.

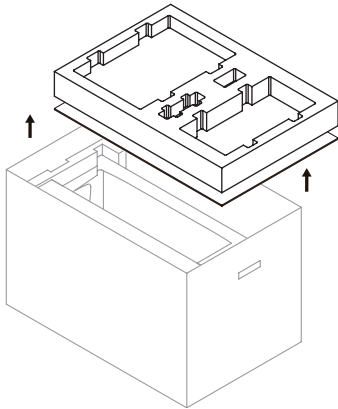

Retain packaging for warranty service.

2.

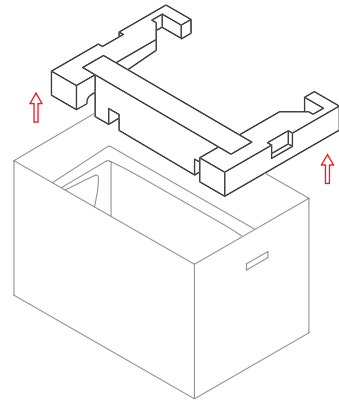

3. Take out the printer with the plastic bag.

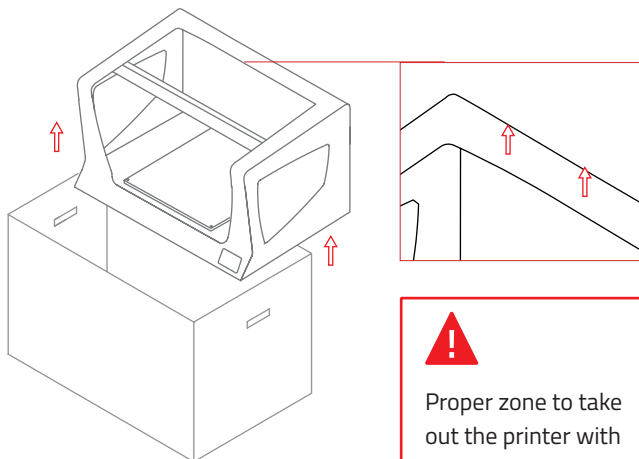

Proper zone to take out the printer with your hands. The machine is heavy. We recommend that someone else help you.

4. Finally, remove the plastic bag and the foam under the platform.

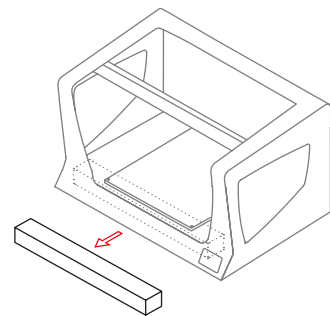

# Contents

---

**Sigma R19:**  
with 0.6mm hotends

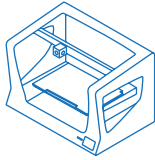

Quick start guide and warranty

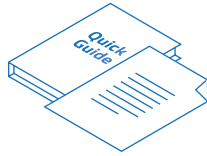

2 Teflon tubes



4 Flat cable clips

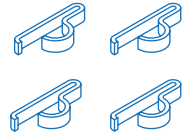

2 Spool holders

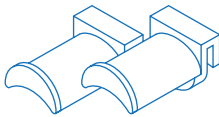

6 Clips



Glass printing surface

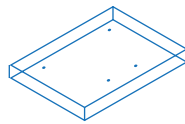

2 0.4mm Hotends

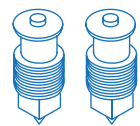

SD card

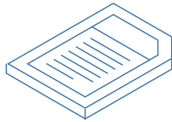

USB and Power cable

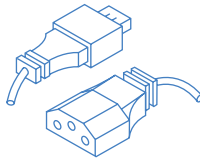

2 PLA spools



Spatula and Pliers

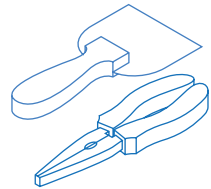

Cross-head screwdriver

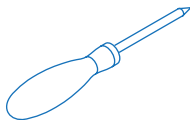

4 Allen keys

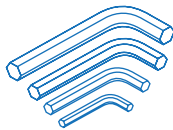

Lubrication Kit

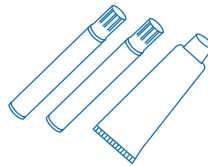

Nylon cleaning filament

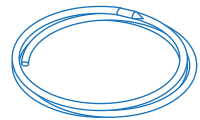

Glue Stick

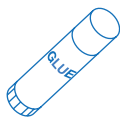

Sample print/Stickers

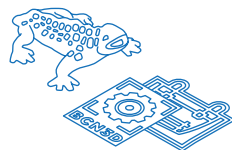

2 Calibration gauges

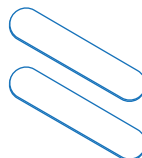

10 Shims

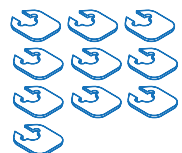

# Set up

---

In order to ensure the safe packaging and transport of your printer some of the components have been sent unassembled. Before starting to print with the Sigmoid R19 printer you need to assemble them in order to complete the setting up process.

If you have any queries while assembling the machine, please contact BCN3D Technologies technical service at [support@bcn3dtechnologies.com](mailto:support@bcn3dtechnologies.com).

Follow the steps below to prepare the printer:

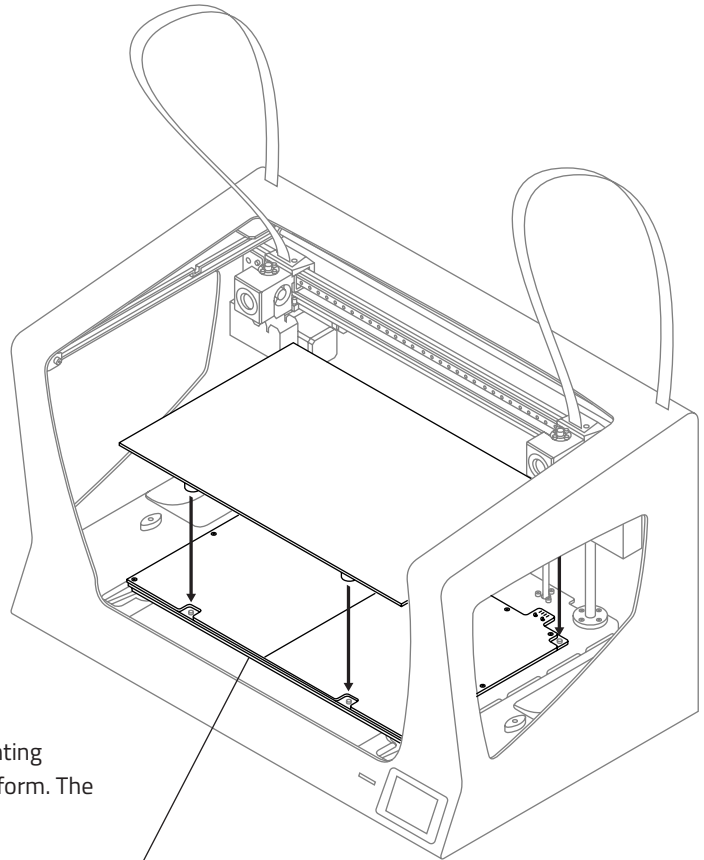

**1.**

Place the glass printing surface on the platform. The slots must match.

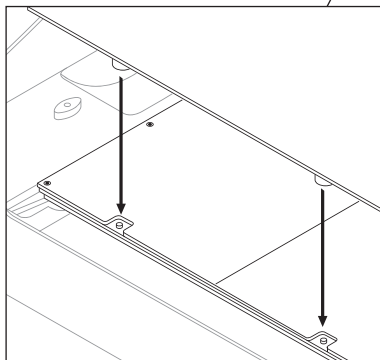

The glass printing surface must be handled with care. In case of breakage, may cause injuries.

# Set up

---

**2.**

Place the spools holders into the spools.

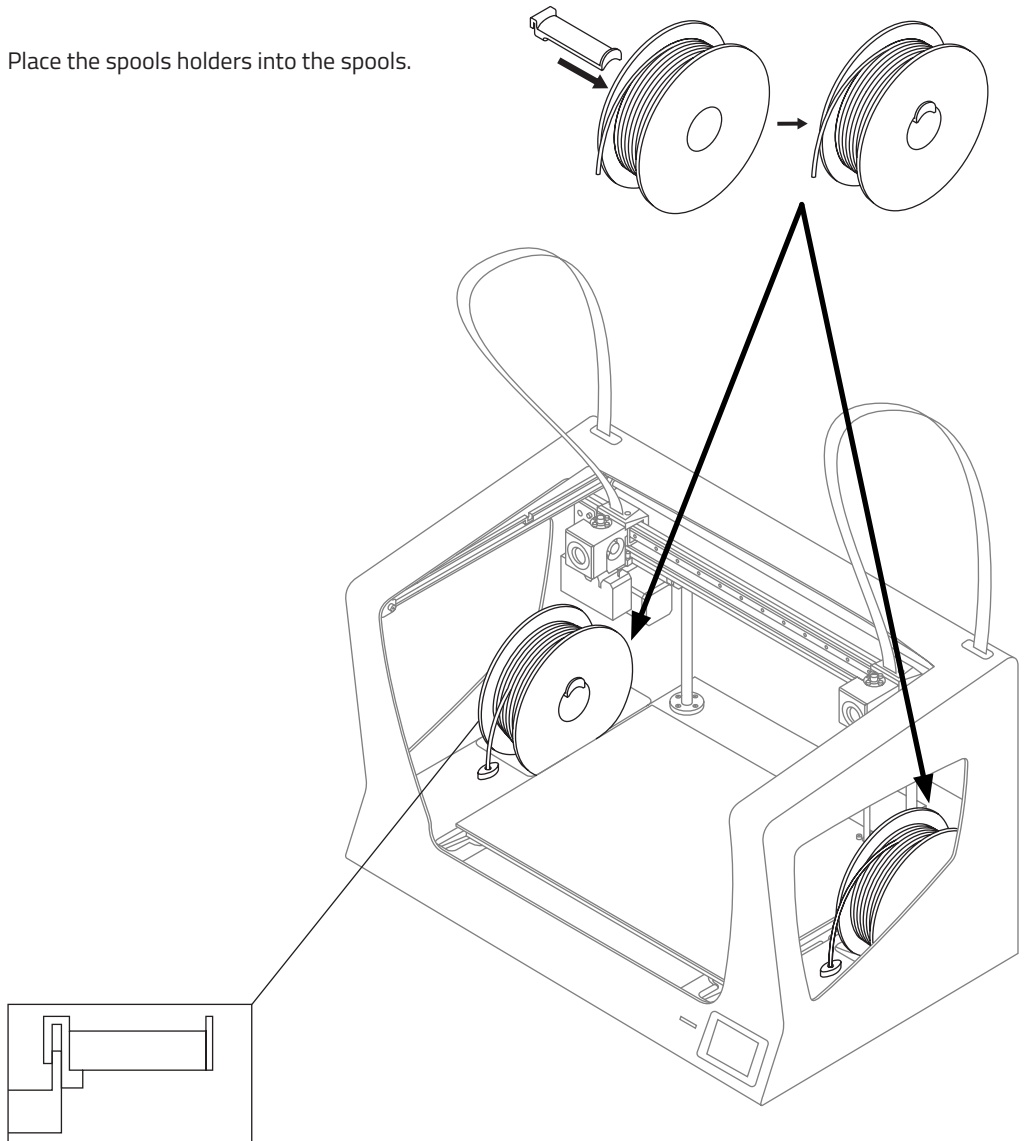

**3.**

Fit them into the indicated holes.

# Set up

4.

Move Y axis manually towards the front in order to work more comfortably.

5.

Insert the teflon tube until it stops.

6.

Insert the opposite end of the teflon tube into the hotend's hole until it stops.

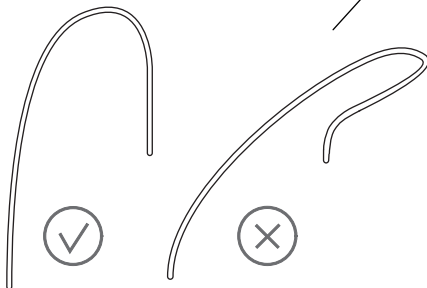
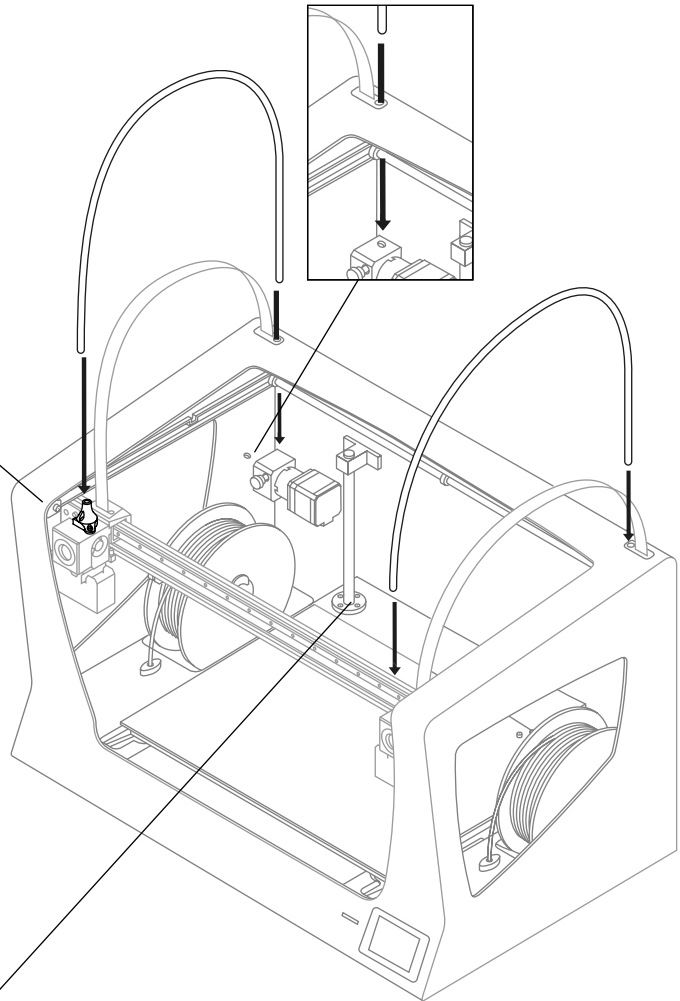
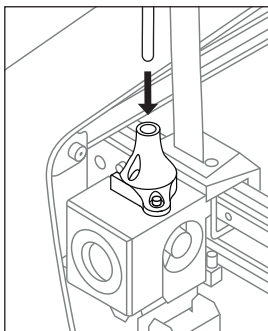

When inserting the teflon tubes, set them up as vertical as possible.



## Set up

---

### 7.

Attach the teflon tubes with the clips.

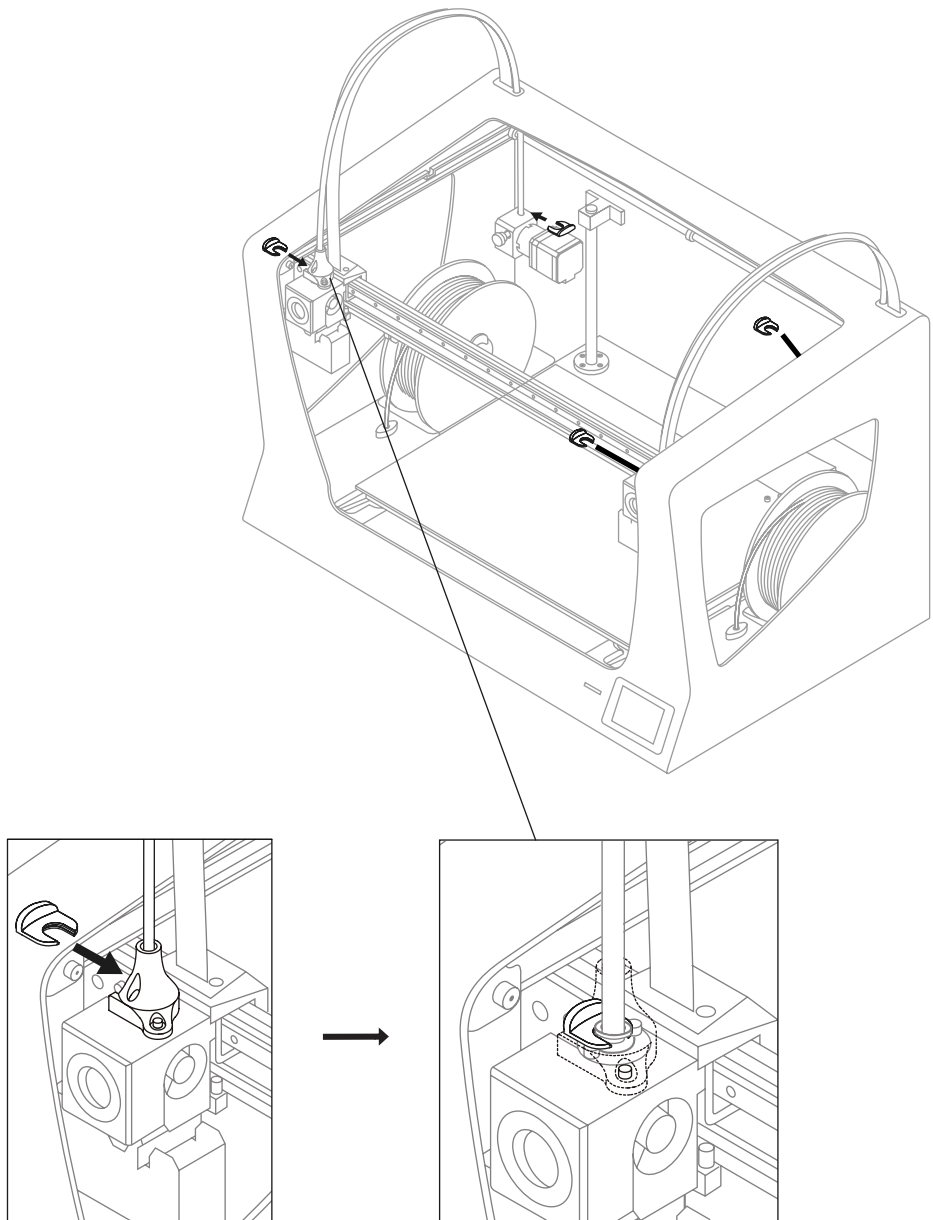

## Set up

---

8.

Put together the teflon tube with the hotend cable using the flat cable clips.

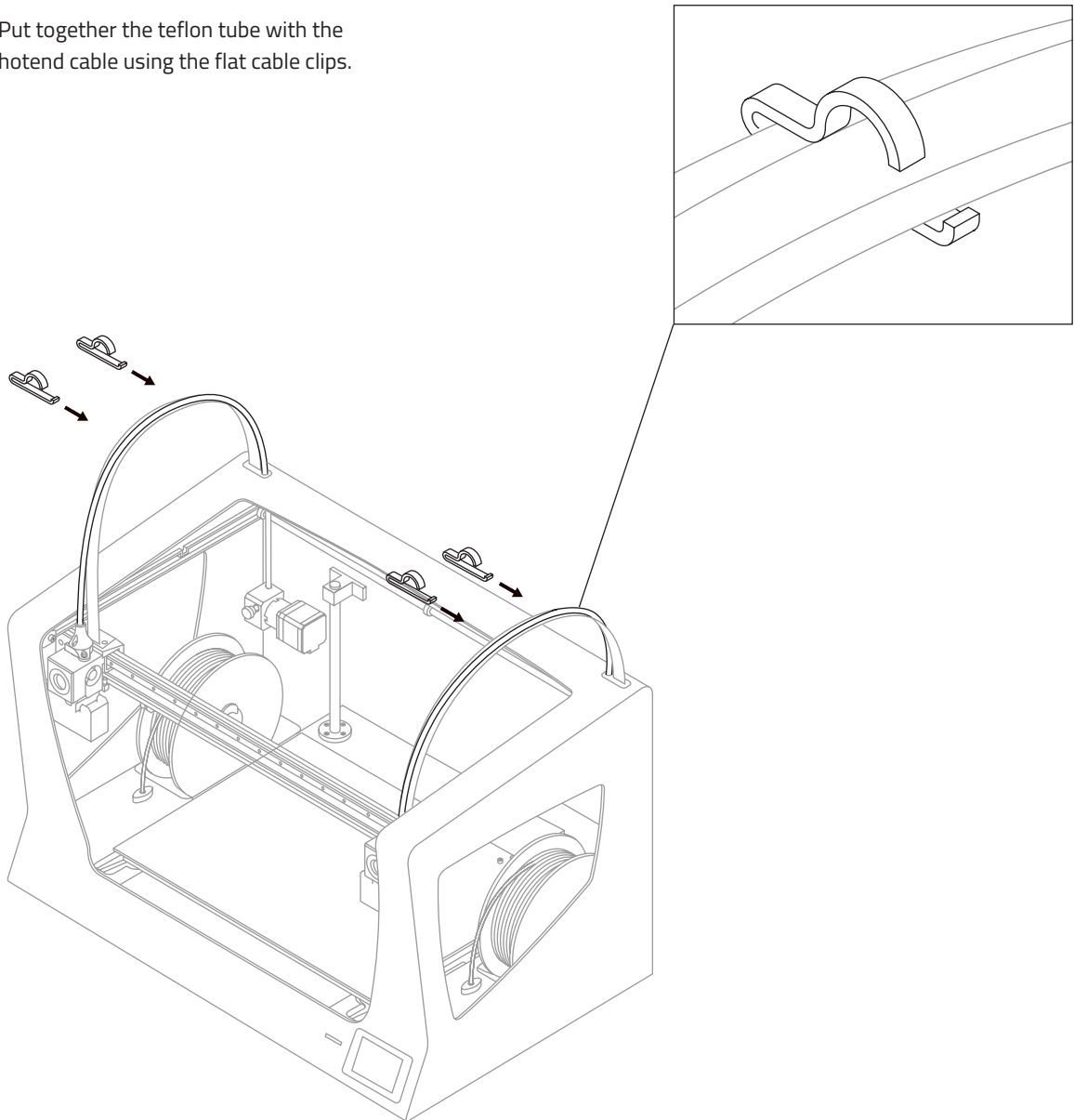

## Set up

---

9.

Connect the power supply cable. The plug is located at the rear of the machine.

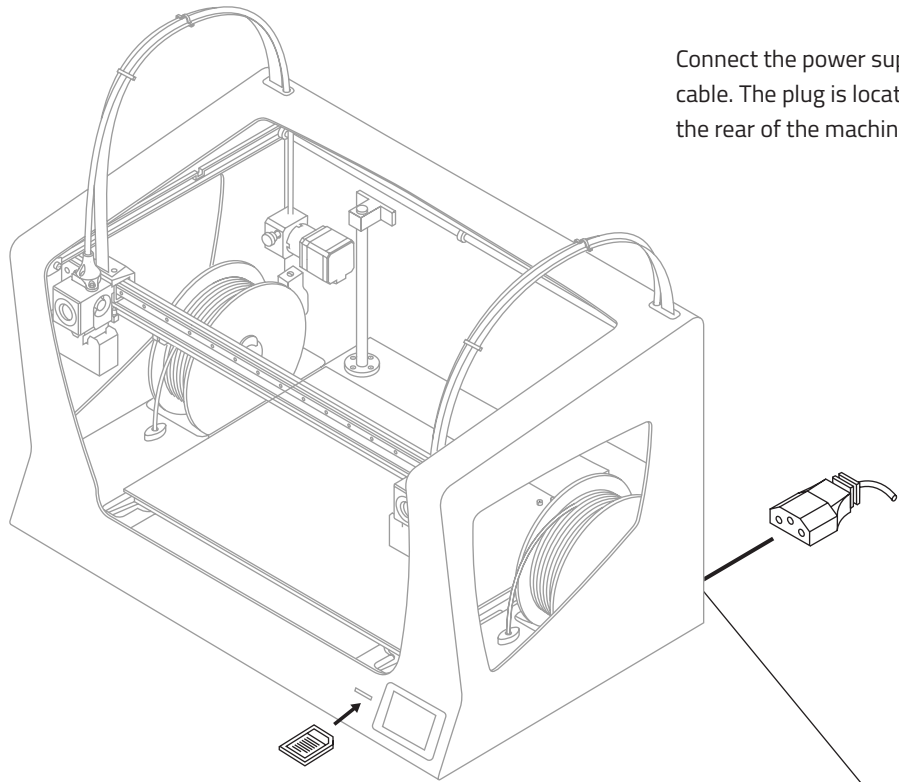

10.

Insert the SD card into the reader.

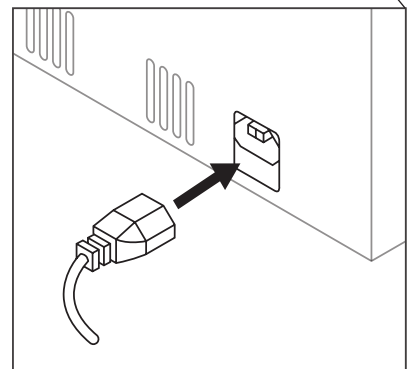

## Set up

---

The Sigmax features an external feeding system to use bigger spools, up to 300mm in diameter, at the back of the printer.

The 3D file in STL format for the external spool support can be found both in the SD card attached and in the BCN3D website:

Support --> Sigmax --> Downloads --> Sigmax Printed Parts --> Exterior Spool Holder

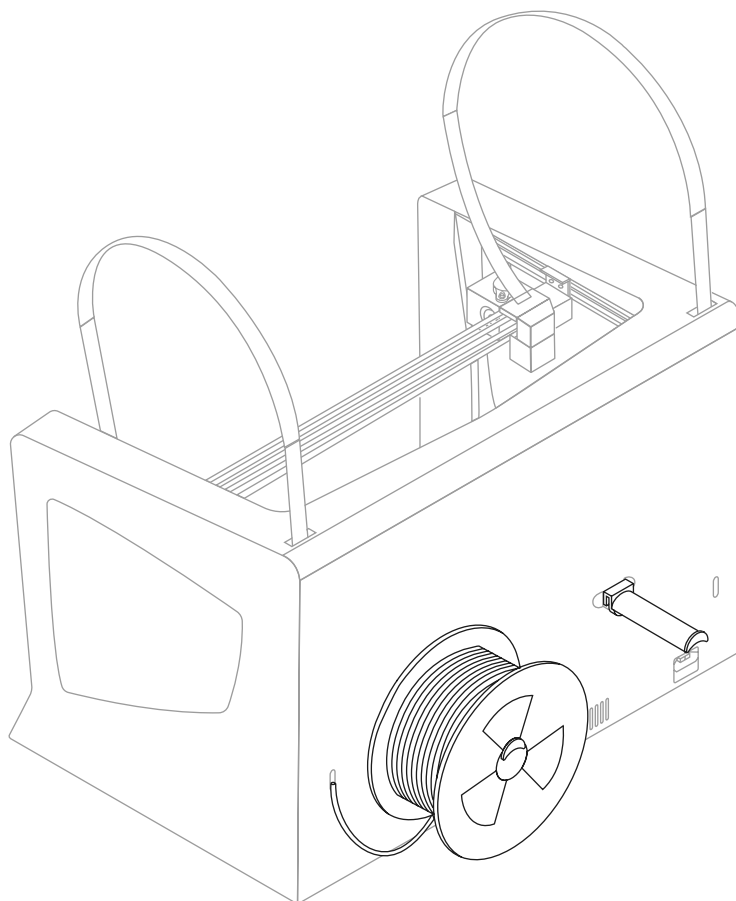

# Getting started

## Setup Assistant

---

### 1. Welcome

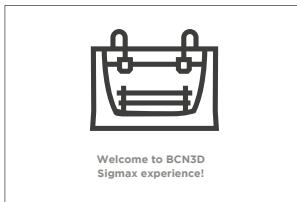

### 2. Setup Assistant

Press *Accept*.

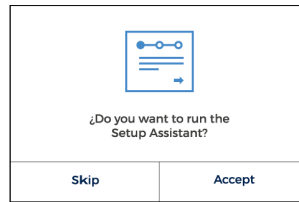

### 3. Load filament

Press *Next*.

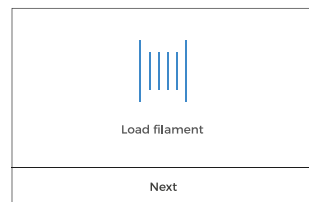

### 4. Select material

Choose PLA.

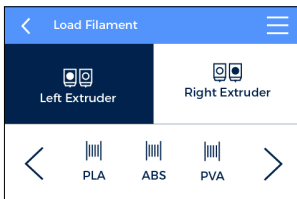

### 5. Follow screen's instructions

in order to load the material.

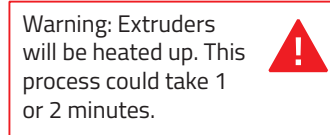
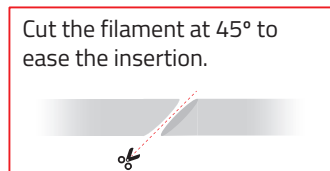

### 6. Repeat the process for the second

extruder.

### 7. Printer calibration

Press *Next*.

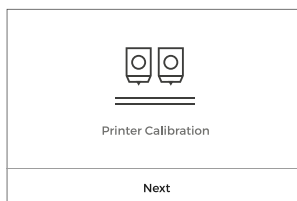

### 8. Glass printing surface calibration.



### 9. Turn calibration screw

as indicated in the touchscreen.

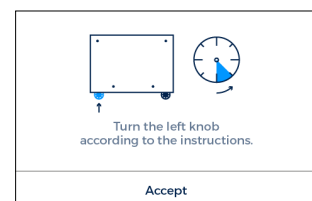

# Setup Assistant

## 10. Z Axis calibration

When indicated on the screen, apply a thin and uniform layer of glue stick on the entire printing surface glass to ensure a better calibration.

11. Place the Calibration Gauge between the nozzle and the printing surface glass. Hold the gauge by the end and move it back and forth, without pressing the platform. Raise the platform until you feel some resistance while sliding the gauge. The gauge should not flex.

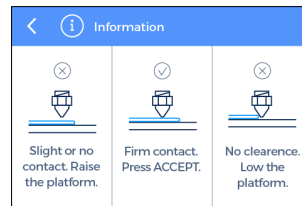
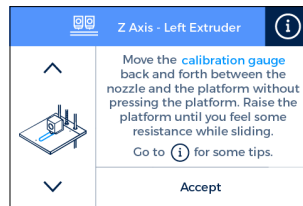

12. The printer will print a test to validate the previous process.

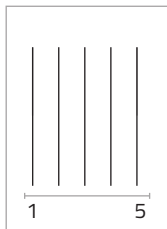

13. Select the best line.

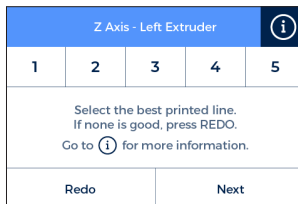

- If the nozzle is too close to the glass, the line will be transparent or non-uniform.
- The line must be adhered to the printing glass and with no gaps.
- If the nozzle is too far to the glass, the line won't be properly adhered to the printing glass and will be gaps in it.

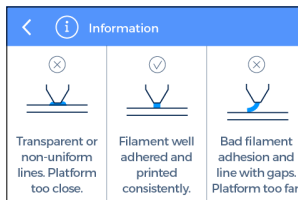

14. Repeat processes 11-13 for the second extruder.

**NOTE:** Depending on the Z axis calibration, it may appear this recommendation screen.

If so, please check next section: "Installing shims" (page 26) for a detailed explanation of the reason, benefits and procedure to perform this operation.

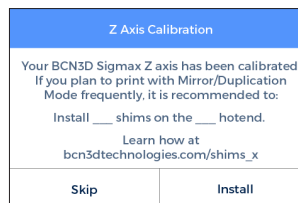

# Setup Assistant

## 15. X Axis calibration

The printer will print vertical lines.

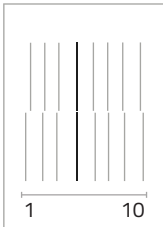

16. Choose the best aligned couple of lines.

Printer Calibration - X axis				
1	2	3	4	5
6	7	8	9	10
Select the best aligned pair of lines, from left to right. Press REDO if none fits or to repeat the test print.				
Redo		Next		

## 17. Y Axis calibration

The printer will print horizontal lines.

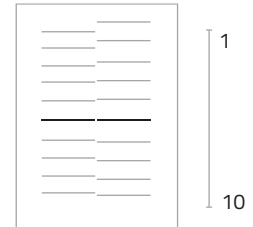

18. Choose the best aligned couple of lines.

Printer Calibration - Y axis				
1	2	3	4	5
6	7	8	9	10
Select the best aligned pair of lines, from top to bottom. Press REDO if none fits or to repeat the test print.				
Redo		Next		

**Congratulations!** Your printer has been calibrated and it is ready to print.

## Mirror and Duplication modes

---

The Sigmax features two new printing modes: Mirror and Duplication. In these modes both toolheads work simultaneously.

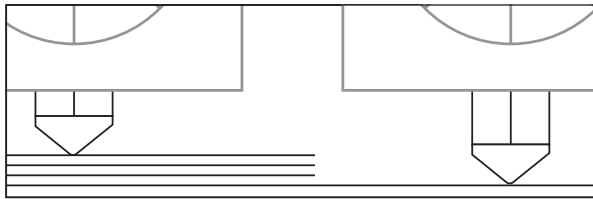
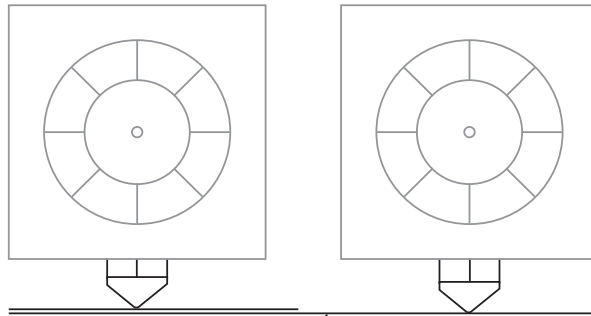

To do it successfully it is key important to make sure both nozzle tips are exactly at the same height. However, due to manufacturing and assembly tolerances the offset between tips can be up to 0.5mm.

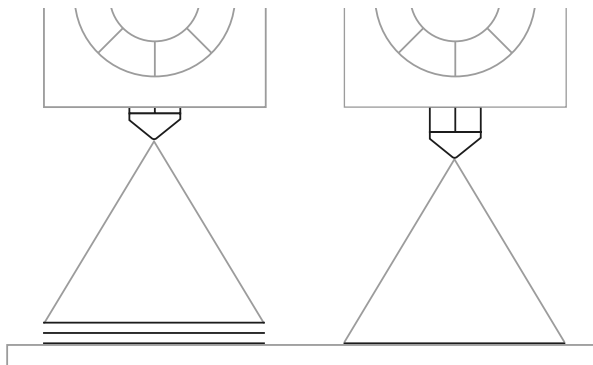

The Sigmax automatically corrects the offsets when printing in Duplication/Mirror modes. However, this correction distorts the first layer of the model by repeating it as many times as needed.



## Mirror and Duplication modes

---

To avoid such distortion there are different options:

1. Enable raft in BCN3D Cura.

The offset will be corrected in the first layers of the raft, so the model won't be affected by any Z offset.

2. Install shims to mechanically correct the Z offset.

Printing a raft takes time and spends material. For those users planning to use frequently the Mirror or Duplication modes, **it is highly recommended to install the shims** when it is suggested during the *Printer Calibration* process.

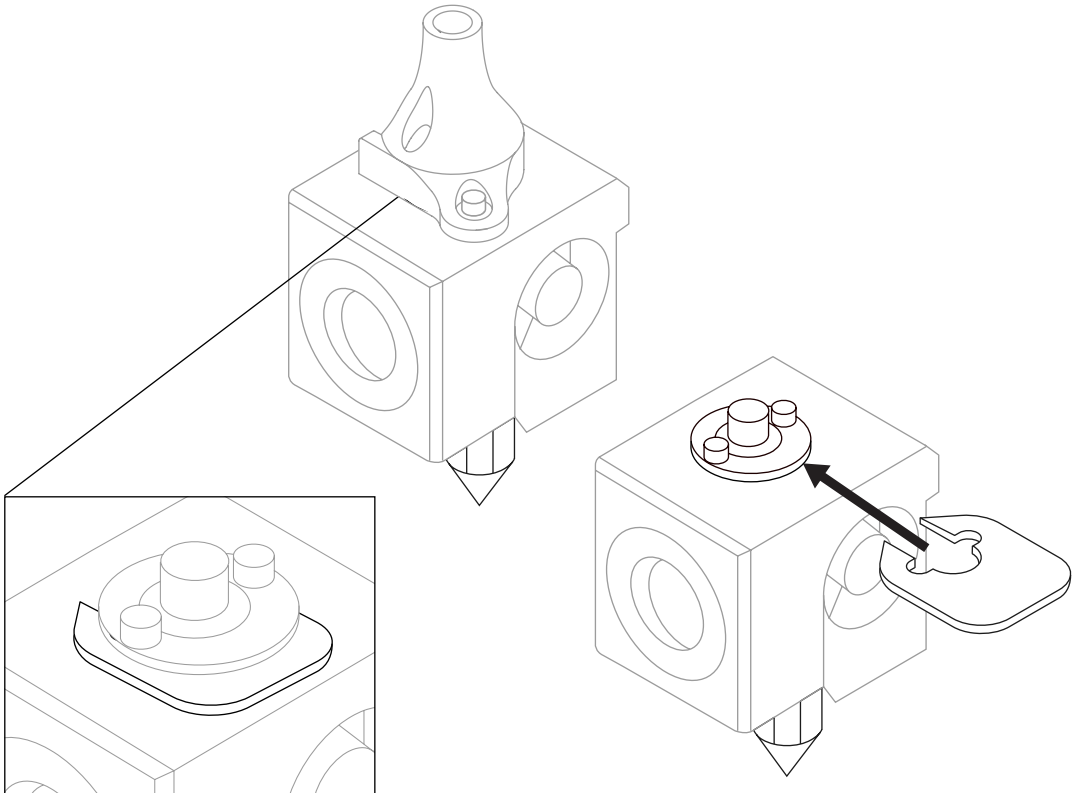

# Installing shims

---

During the *Printer Calibration* process or before printing a job with Duplication or Mirror mode, the Sigmax may suggest you to install shims to correct the Z offset between nozzle tips.

Once you confirm you want to install the shims, remember the number of shims to install on which hotend and just follow the screen instructions:

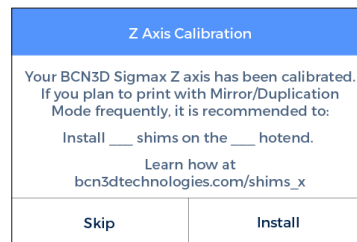

1.

Wait until the printer cools down to avoid any dangerous manipulation.

3.

Remove the black piece to work more comfortably.

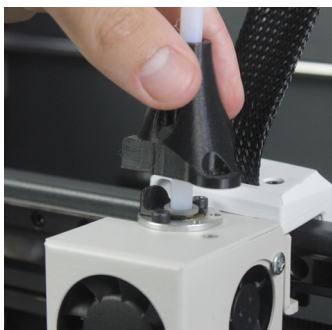
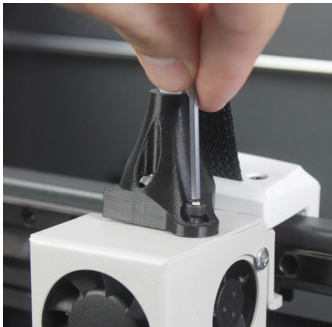

2.

Turn off the machine.

4.

Unscrew the 2 bolts at the specified hotend .

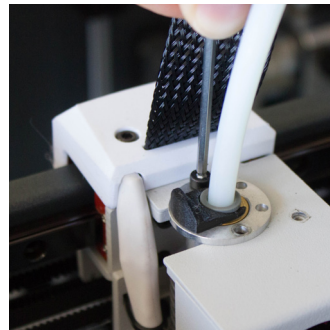
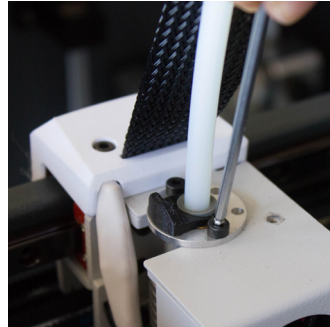

## Installing shims

---

5.

Install as many shims as were indicated in the screen.

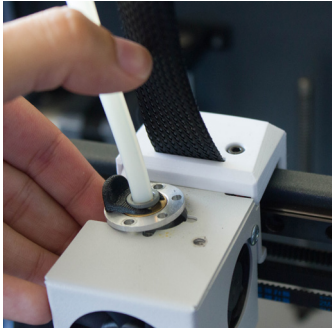

6.

Screw the bolts again.

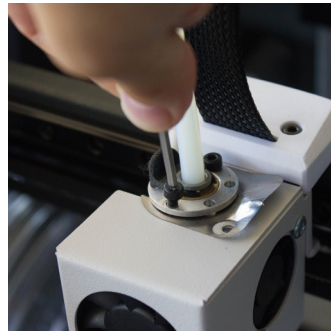
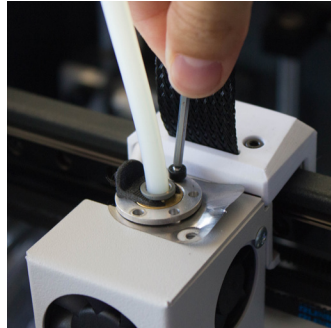

7.

Put the black piece again in its place and screw the bolt again.

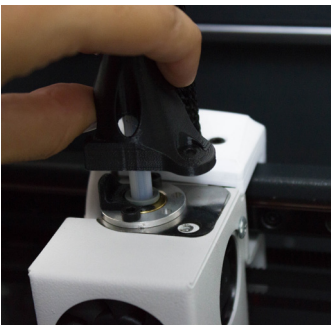

8.

Turn on the machine and follow the instructions on the screen.

# First print

---

After the calibration process has been completed, you can access the printing menu. The first object you will print with the Sigmoid R19 is the Draudi figure, as it will allow you to check that everything is working properly and you are now ready to start printing your own objects. Make sure that the glass is clean, and apply a small amount of the included glue stick. Learn how to use the slicing software BCN3D Cura and how to print your own objects in the next chapter.

*Print --> Sample Parts --> Dual --> Dual Draudi --> SxR19\_DualDraudi*

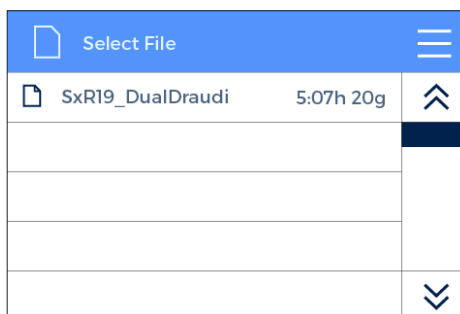
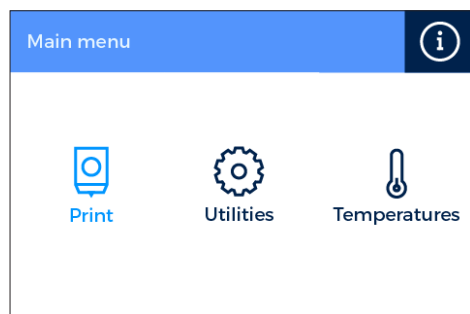

# Starting out with BCN3D Cura

BCN3D Cura is a free and easy-to-use 3D printing software that prepares your digital model for 3D printing. Such a complex process has been carefully optimized and tested for BCN3D products. As a result, the user enjoys a flawless 3D printing experience while increases the reliability of the process.

BCN3D Cura takes profit easily of all the benefits of IDEX system: simply merge multi-material or multi-colour models or generate customized support structures. It includes validated printing profiles to increase the printing success rate.

Visit <https://www.bcn3dtechnologies.com/en/3d-printer/bcn3d-cura/> and download the suitable version of BCN3D Cura for your Operative System. Once downloaded, follow the installation wizard.

## Your first dual print

---

1. Open BCN3D Cura previously downloaded and installed.

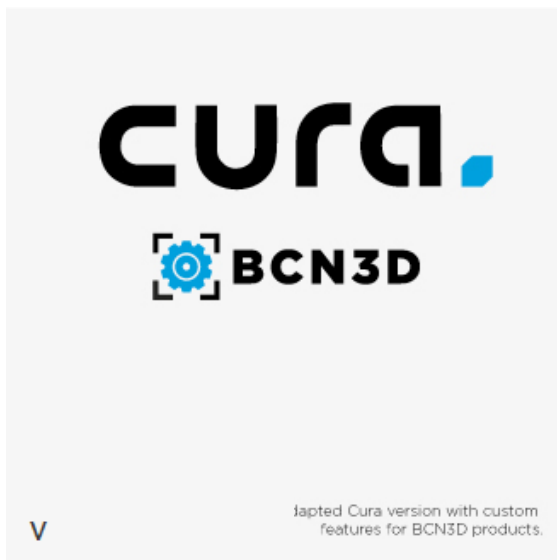

2. Select Sigmax R19 in the menu *Add printer*.



# Your first dual print

3. Click *Open File*.

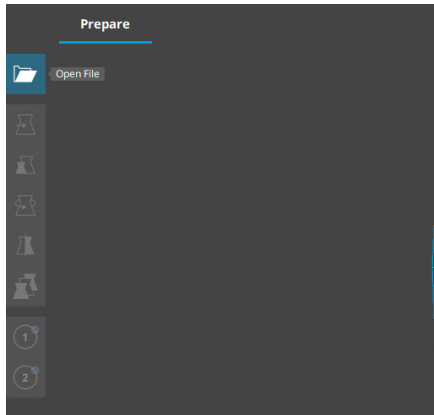

4. Select files to print.

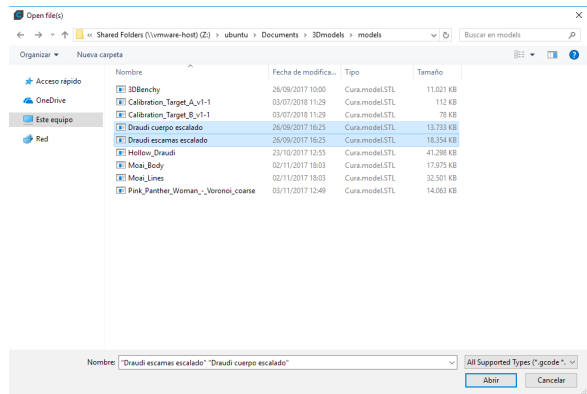

5. Click the model and assign the extruder to print with.

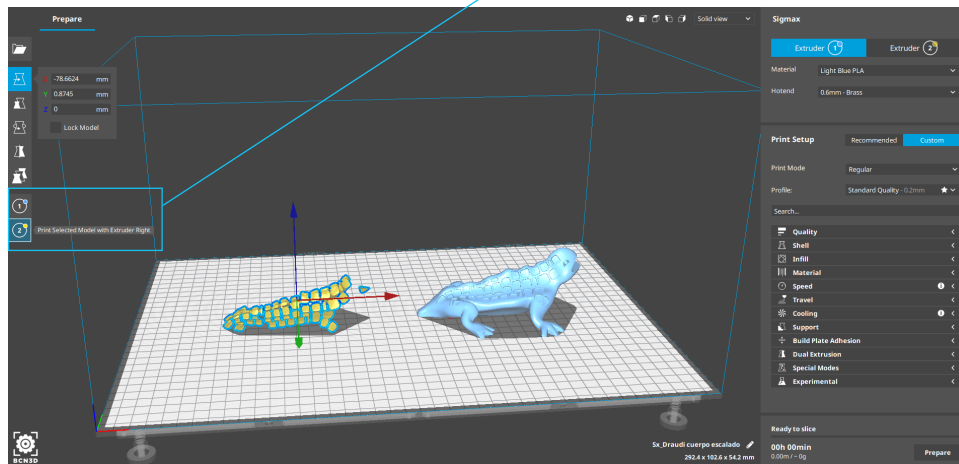
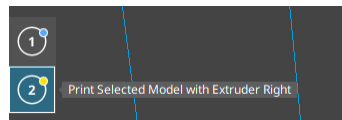

# Your first dual print

6. Select the models by Shift+Left Click. Selected models will be highlighted with a blue outline. Right click on any of the selected models, and select *Merge Models*.

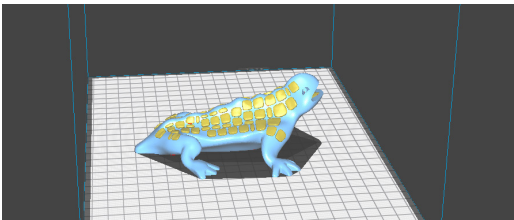
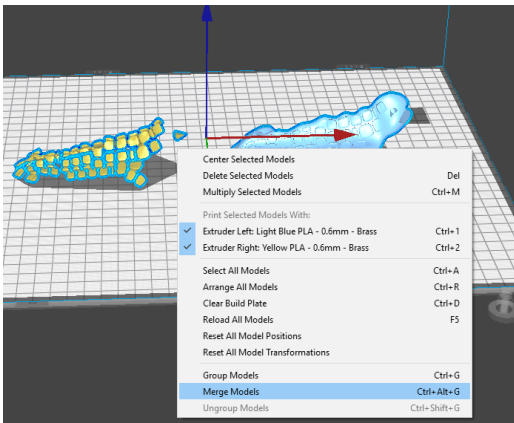

9. Insert the SD card in your computer and save the file.

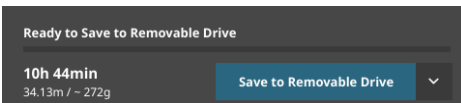

7. Select profile.

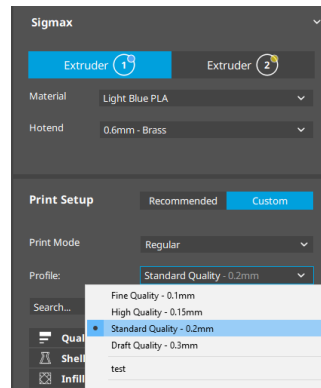

8. Click *Prepare* to generate the printing file.



10. Safely remove the SD card from the computer and insert it in the printer. After that, turn it on.

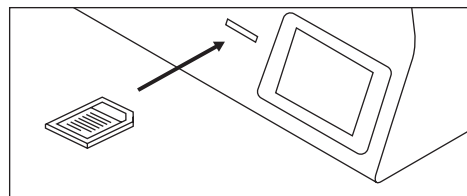

# Your first dual print

11. Select *Print* in the main menu of Sigmoid's touchscreen.

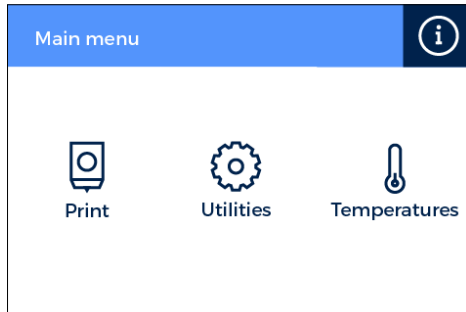

12. Before selecting the file to print, remember to apply a uniform amount of the included glue stick on the glass printing surface. Then, select the file to print.

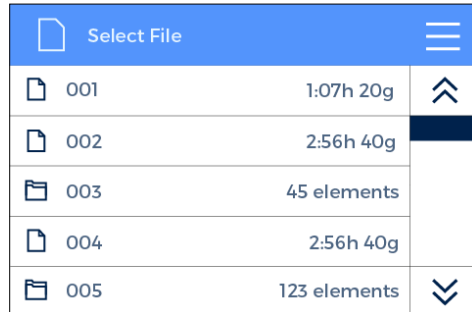

If your printed part has adhesion problems with the glass printing surface, we recommend using alternative adhesives solutions, such as 3DLac or Dimafix. You can find them at our website <https://www.bcn3dtechnologies.com/en/3d-printer-spare-parts/>

**Congratulations!** You have started printing your first 3D part with the Sigmoid R19.



# First Mirror /Duplication print

1. Load files to print and move, scale or rotate the models as needed.

2. Select the printing profile for the Left Extruder. Make sure the hotend and material loaded at Right Extruder are the same than in the Left Extruder.

3. Select the desired printing mode in the drop-down list.

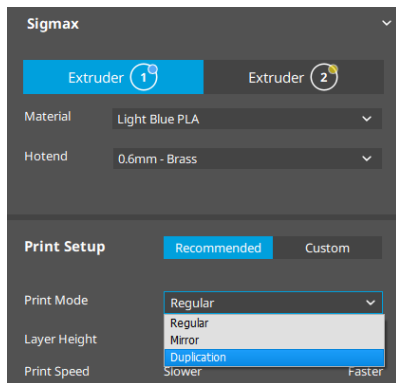

4. Note how the available printing volume is reduced and the loaded models automatically move to the left. These models can still be modified. A preview of the duplicated or mirrored parts is available at the right.

5. Click *Prepare*, save the file and print it. Before selecting the file to print, remember to apply a uniform amount of the included glue stick on the glass printing surface.

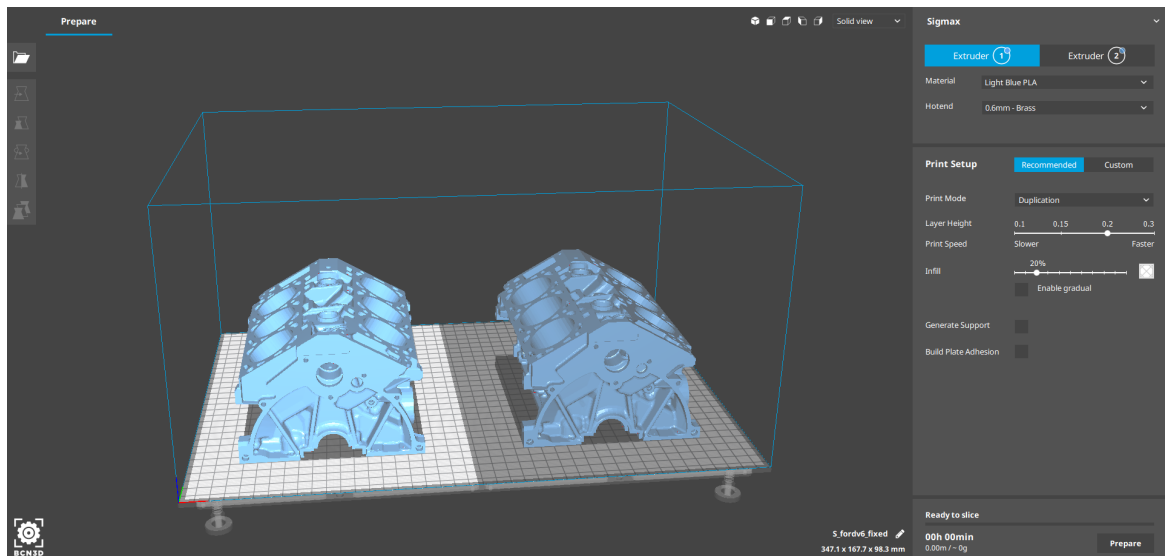

If your printed part has adhesion problems with the glass printing surface, we recommend using alternative adhesives solutions, such as 3DLac or Dimafix. You can find them at our website <https://www.bcn3dtechnologies.com/en/3d-printer-spare-parts/>

Contact us if you have any questions about this process: [support@bcn3dtechnologies.com](mailto:support@bcn3dtechnologies.com)

# Firmware upgrade

At BCN3D Technologies we want you to have a great printing experience, and to achieve this we are continually working to create new firmware upgrades for our printers. Follow this process through BCN3D Cura for checking if the latest firmware version is installed on your printer. If not, it will get the latest firmware and it will be installed.

1. Use the USB cable to connect the Sigmoid to the computer.
2. Open BCN3D Cura. Go to *Settings* --> *Printer* --> *Manage Printers*

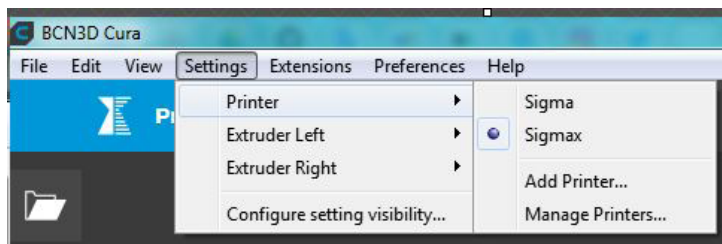

3. Select *Upgrade Firmware*.

4. Click *Automatically upgrade Firmware* to download and install the latest version available.

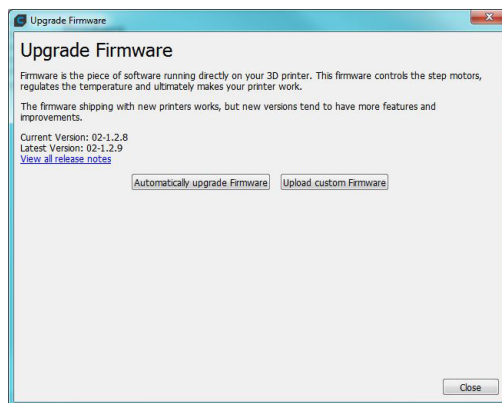
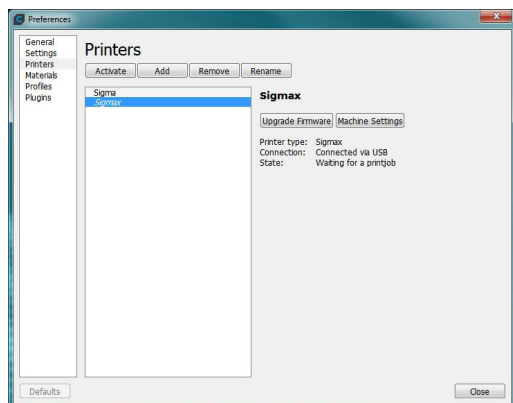

## Firmware upgrade

5. Wait until the firmware is installed. The process may take a few minutes to complete.

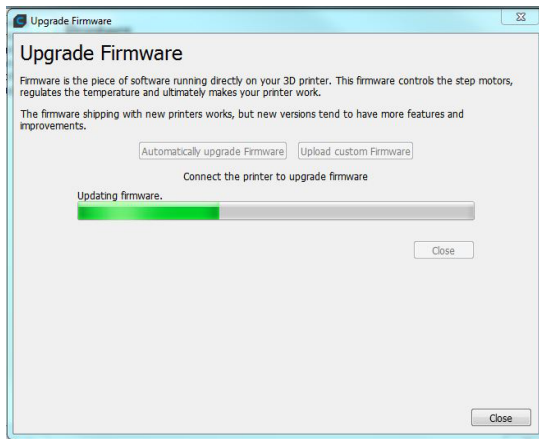

6. Once the process is completed, close the window.

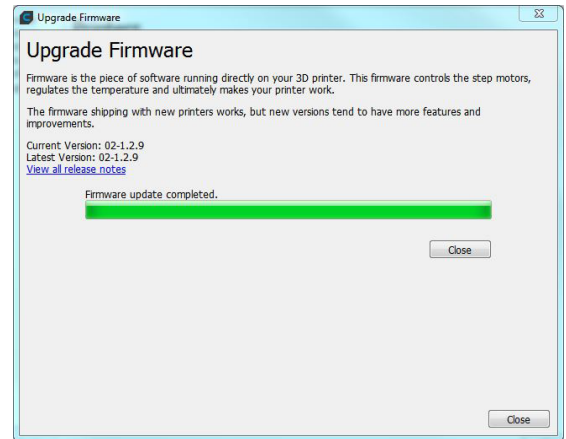

**¡Congratulations!** You have upgraded the firmware of your Sigmex R19.

# Functionalities

This section contains a description of Sigmax R19 functionalities. The main menu is divided into three large groups: print, utilities and temperatures. The first covers all the standard printing functions. The second includes functions such as calibration, maintenance, settings. Finally, the third allows to preheat the printer.

## Print

Located on the left-hand side of the main menu, select a print job to start the printing process. You can control some of the parameters of the settings while the object is being printed from here.

**Select object:** When you access the printing function a screen appears with a list of files and folders. Use the onscreen arrows to navigate and then click on the selected file to confirm your selection.

**Print:** This screen displays the progress of the printing process and show the basic information about time left, file progress and temperatures.

Press the Pause button to move the extruders away from the object and stop the printing process. When the printjob is paused it is possible to load/unload or purge filament, adjust the light intensity as well as cancel or resume the print.

The Stop button let's you whether cancel the printing process and take you back to the main menu or save the printjob.

**Settings:** This option bring you a new menu:

–**Temperatures:** Adjust the hotend and heated bed temperatures by using the arrows.

–**Advanced settings:** Adjust the speed, fan and flow-rate values by using the arrows.

–**Light intensity:** Use the toggle to adjust the LED luminosity.

## Utilities

Situated at the center of the main menu, allows you to operate and maintain your printer.

**Filament:** this menu allows you to manage the filaments of the printer. The menu functions are:

–**Load:** This is for loading filament into one of the extruders. You should first select the side where you want to load the filament. Next, you should insert the filament into the extruder following the onscreen instructions (the extruder should first reach the right temperature, which may take a few minutes). Once you have inserted the filament the extruder can be adjusted slightly to allow you to load the rest of the filament. When purging we recommend you pull out a generous amount of filament to ensure the extruder is purged correctly.

BCN3D Filaments presets are offered, but it's possible to load different materials. Just select *Custom* and set the 2 temperatures demanded. Follow the manufacturer indications to set the *Printing Temperature* and the *Heated Bed Temperature*.

–**Unload:** This operation is the opposite of the operation described above, although it is performed in a similar way. After you have selected which side you want to remove the filament from, wait until the hot-end has reached the right temperature and then remove the filament.

–**Purge:** This menu allows you to control the temperature of the two hot-ends, and extract or dislodge clogged filament. In order to be able to move the filament, the temperature difference between the objective temperature (under the thermometer) and the actual temperature (under the extruder icon) should be less than 10° C.

**Calibrate:** This menu allows you to calibrate the Sigmax R19 printing surface glass and extruders. This process should be performed when components are replaced, and during standard printer maintenance (described in this manual).

## Functionalities

–**Printing Surface Calibration:** This option allows you to level the printing surface. The process is performed by an onscreen self-test run by the printer, followed by instructions to correct the position. The screen displays how many turns (in eighths of a turn) each of the levelling screws should be turned, and in which direction.

–**Printer Calibration:** This option allows you to perform a full calibration, where the heated bed and the relative positions of the extruders are calibrated. You will be guided by onscreen instructions, and the aim is to select the best of the different test prints performed by the printer.

–**Manual Fine Calibration:** This option lets you to manually modify the calibration values found in the Printer Calibration process. On the left menu, select the axis to adjust and press the arrows to correct the calibration value.

### Maintenance

–**Move Printing Surface:** This option lets you to move the platform up and down.

–**Hotend Cleaning Assistant:** Perform this operation to clean the hotend. Just follow the instructions of the screen. This operation is recommended when you notice any sign of underextrusion, when switching materials and after printing with soluble or special materials.

–**Autotune hotends:** Select this operation every time you change the hotend. The internal routine will check the thermal behaviour of the hotends installed and will allow the printer to have a better temperature control.

### Printer Setup

- **Change hotend:** Start a guided process step by step to change and calibrate a hotend.

- **Printing Components Setup:** Manually set up the nozzle sizes installed in the printer and the use of the Filament Runout Sensor.

- **Light intensity:** Use a toggle to adjust the Light Intensity.

- **Run Setup Assistant:** A step by step process to calibrate the printer, as it was straight out of the box.

## Temperatures

Placed on the right-hand side of the main menu, lets you to preheat or cooldown the hotends and the heated bed. The preheat temperatures will be set depending on the filaments loaded.

# Operation and maintenance

## Change hotend

By default, the Sigmax is equipped with 0,6mm hotends, but is possible to change them to tackle different print jobs.

Changing the hotend is an easy operation that can be performed in a few minutes. You will need:

- Scissors or cutting pliers
- 2,5mm hex key
- Pliers
- Zip ties

1. Operating the printer via the LCD screen, go to *Utilities* --> *Printer setup* --> *Change hotend*.

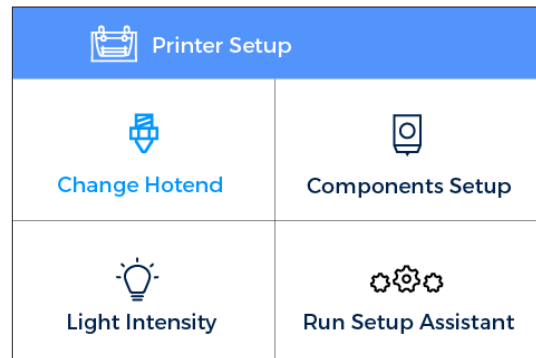
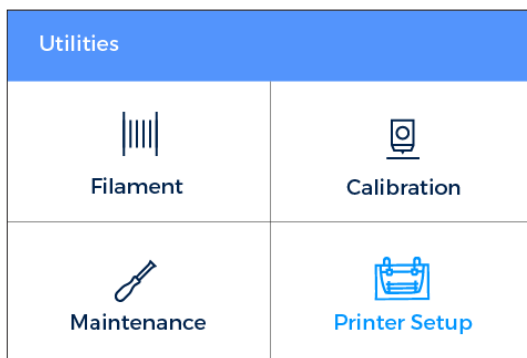

2. Select the hotend to change and unload the filament (in case there's some loaded).

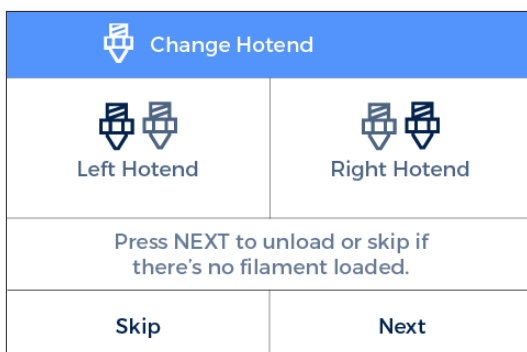

3. Wait while the hotend cools down.

## Operation and maintenance

4. Turn off the Sigmax when the LCD indicates it.



Turn off the Sigmax and change the hotend.

Learn how at  
[bcn3dtechnologies.com/changehotend\\_x](https://bcn3dtechnologies.com/changehotend_x)



5. Remove the black piece to work more comfortably. Then remove the black clip. Finally, hold down the coupling collet and pull out the teflon tube.

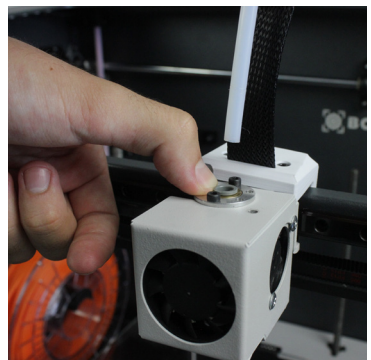
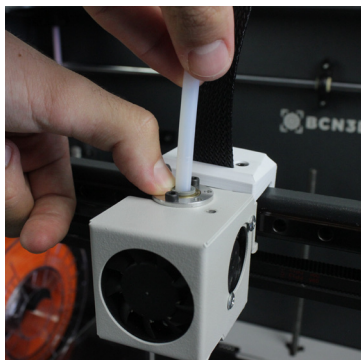
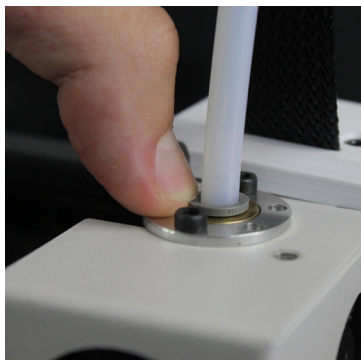
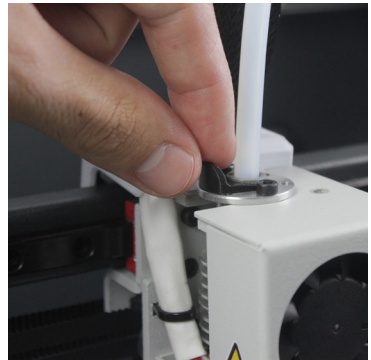
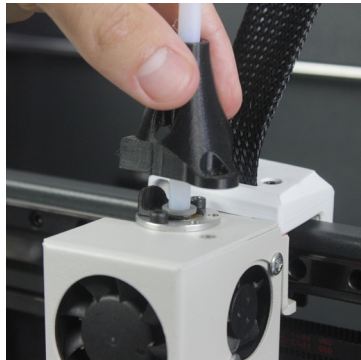
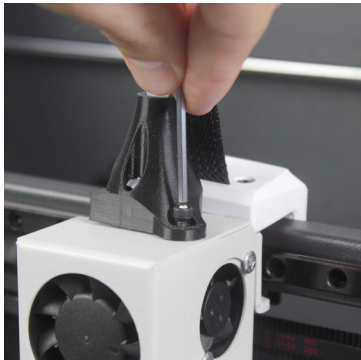

## Operation and maintenance

6. Unscrew the cover and remove it.

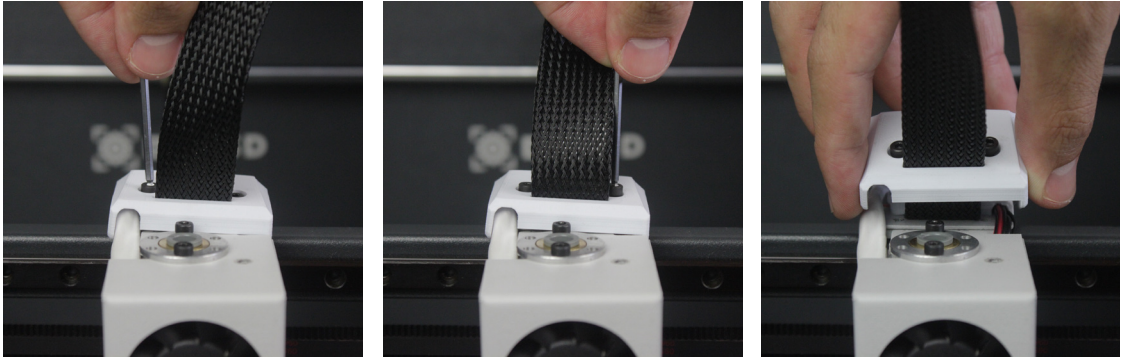

7. Unscrew the hotend.

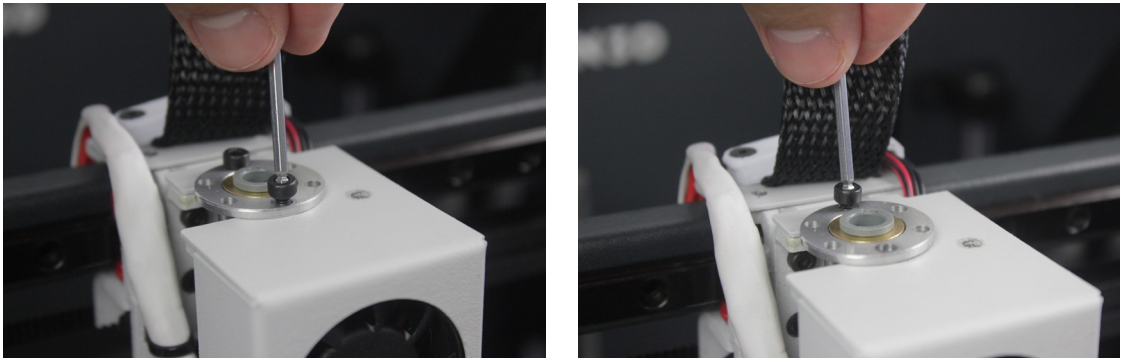

8. Cut the zip tie and remove it.





## Operation and maintenance

9. At the back of the toolhead carriage, press the connector to remove the cable of the hotend.

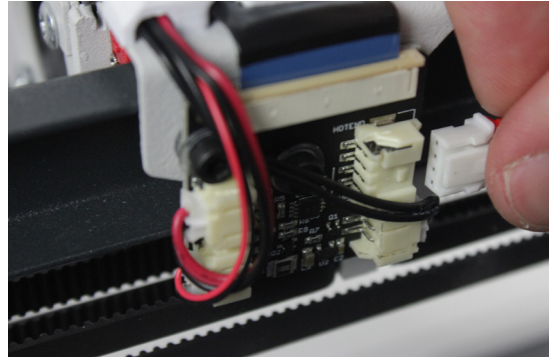
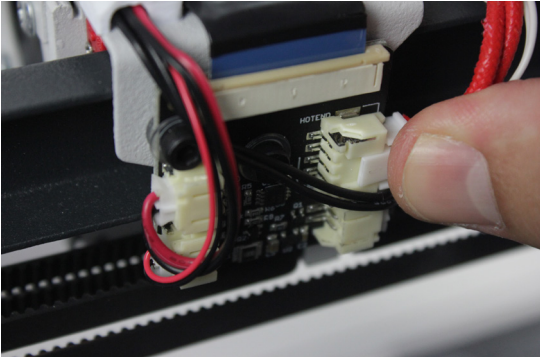

10. Remove the old hotend and place the new one, connecting it at the back of the toolhead carriage.

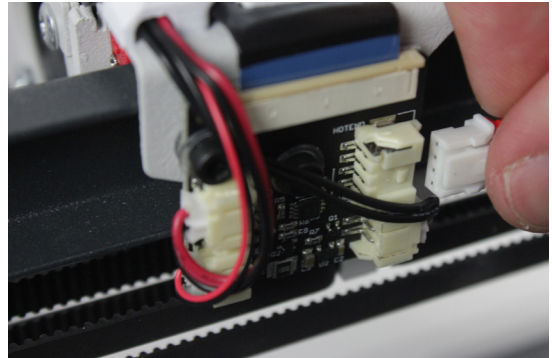
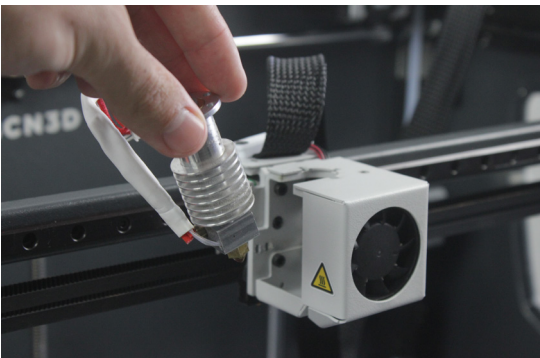
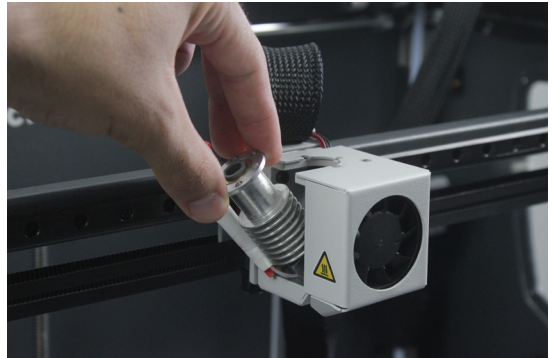
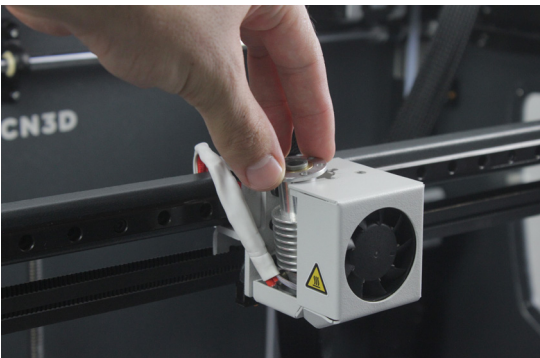

## Operation and maintenance

11. Place and adjust the zip tie, cutting off the excess.

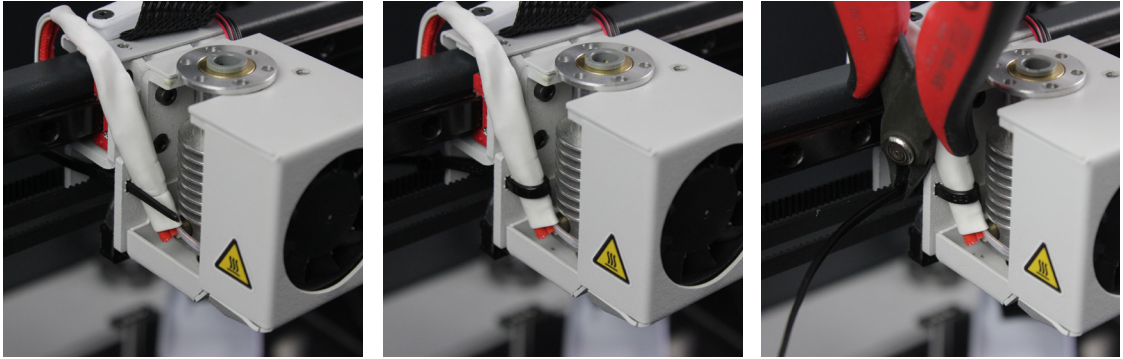

12. Screw the hotend, place the cover and screw it.

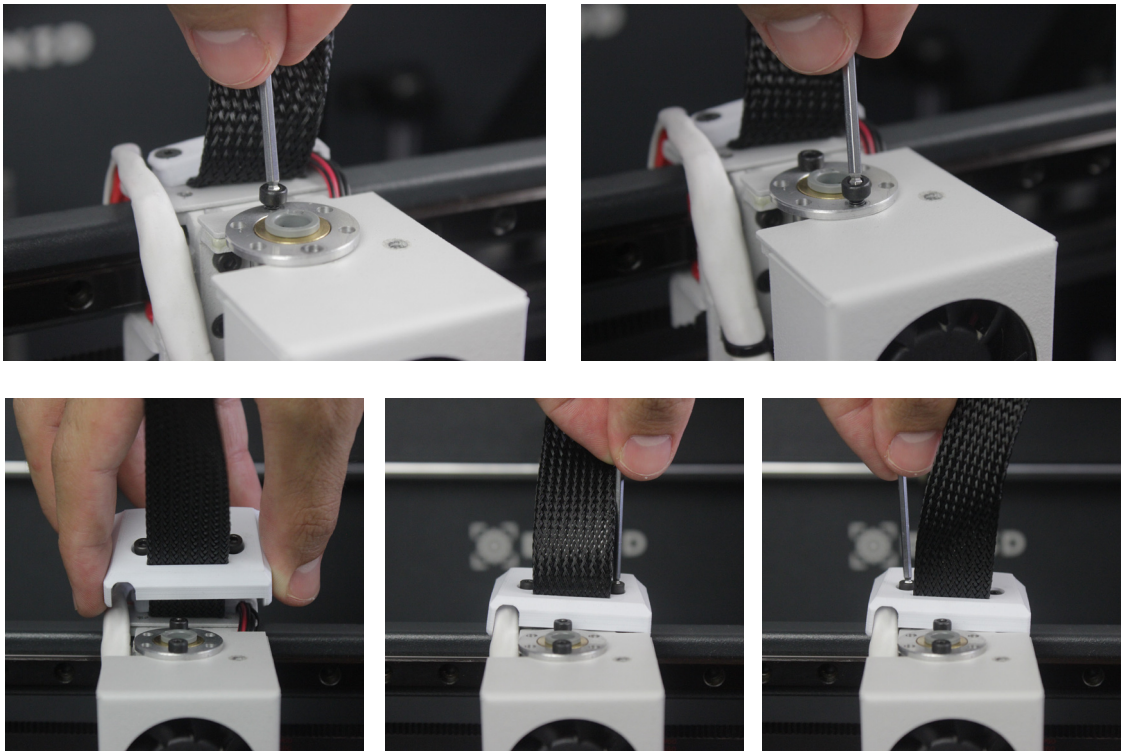

## Operation and maintenance

13. Insert the teflon tube until it stops, making sure it is well placed. Put back the black clip and the black piece.

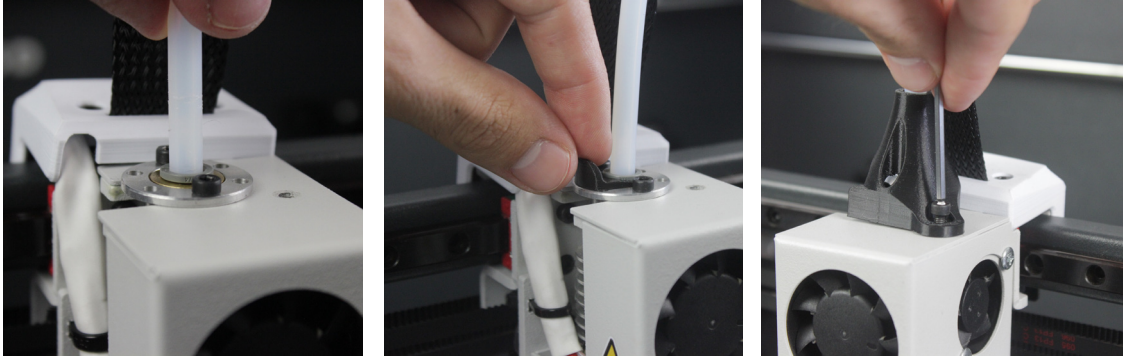

14. Turn on the Sigmax and follow the screen instructions. Select the hotend size you have installed.

Change Hotend		
0.3	0.4	0.5
0.6	0.8	1.0
Select the nozzle size that you've installed.		
Save		

15. Load filament and perform an autotune operation.

Load Filament	
It's necessary to load filament in order to autotune and calibrate the hotend.	
Skip	Load Filament

16. Finally, calibrate the offset between hotends.

Autotune Hotend	
It's recommended to autotune the hotend to improve its thermal stability.	
Skip	Autotune

Printer Calibration	
When the hotend is changed the calibration values vary. For this reason, it's required to calibrate the Sigmax.	
Skip	Calibrate

## Operation and maintenance

### Clean and lubricate axes

Periodically, according to the Maintenance Alerts via LCD screen, it is recommended to clean and grease the axes of the Sigmax with the lubrication kit to ensure smooth and precise performance of its mechanical components.

Follow these steps:

1. From the LCD screen, go to *Utilities* --> *Maintenance* --> *Move printing surface*. Lower the platform to the lowest position to work more comfortably. Then turn off the machine.

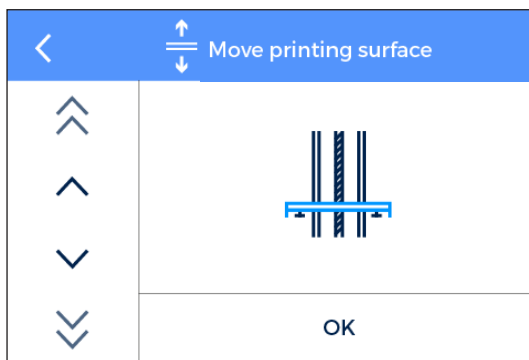

2. With absorbent paper or a cloth, remove any trace of dirt or dust at the two Z shaft bars. Next, clean the shaft bars with the solvent pencil, making sure that it does not drip. Clean again the shaft bars with paper or a cloth.

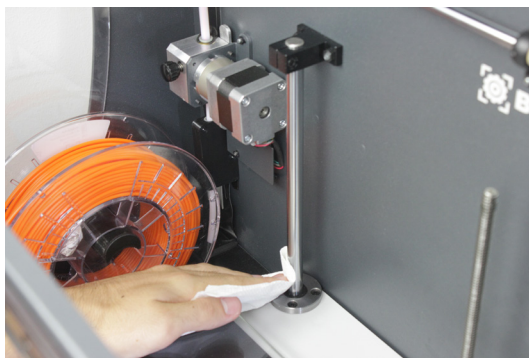

## Operation and maintenance

3. Apply the lubricating oil pencil along the Z shaft bars, making sure that it does not drip.

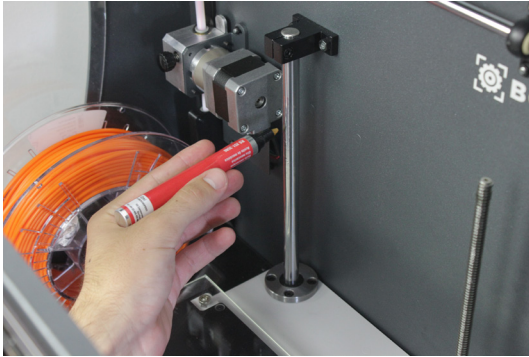

4. Clean grease and dust from the Z-axis motor spindle with paper or a cloth. Turn the spindle manually to access its rear.

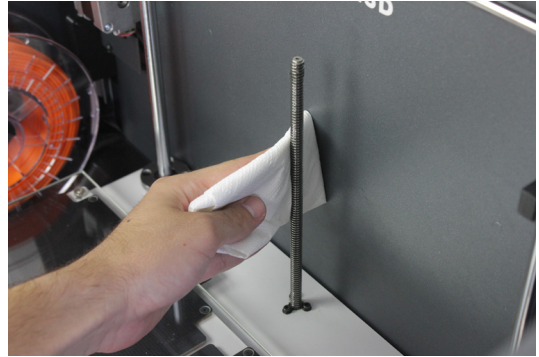

5. Apply the grease along the spindle of the Z-axis motor.



6. Turn on the Sigmax and from the LCD screen, go to *Utilities* --> *Maintenance* --> *Move printing surface*. Raise and lower the platform twice to evenly distribute the oil and grease. Finally, remove the remnant grease.



## Operation and maintenance

7. Once the process for the Z axis is finished, let's clean and lubricate X and Y linear guides. First of all, turn off the Sigmax. During this process it's recommended to manually move the axes in order to reach all the guide.

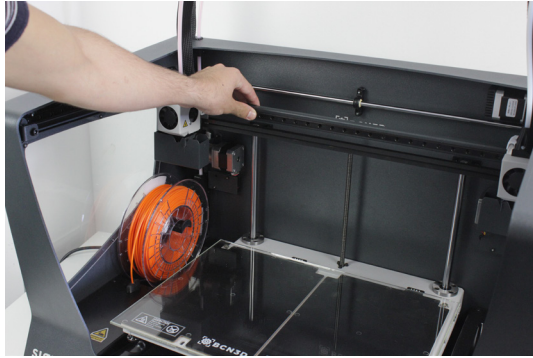

8. From the center towards the ends of the linear guides of the X and Y axes, remove dirt with an absorbent paper or a cloth.

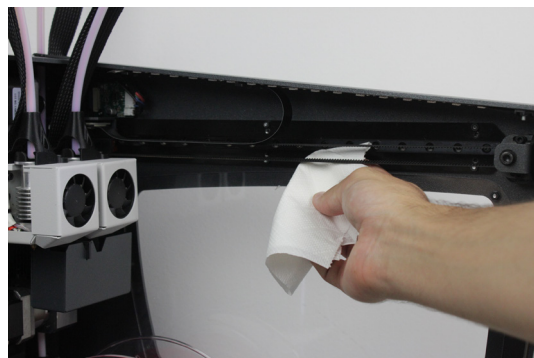

9. Clean the guides with the solvent pencil, making sure that it does not drip with special emphasis on the superior and inferior faces.



## Operation and maintenance

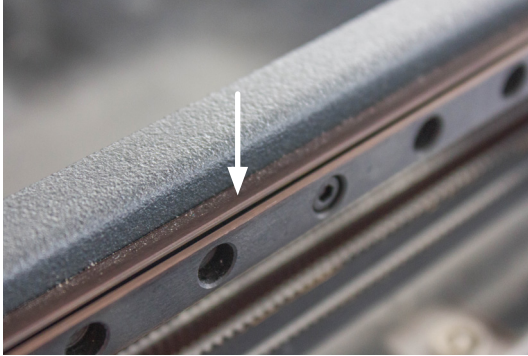

**10.** Clean again the X and Y guides with an absorbent paper or a cloth.

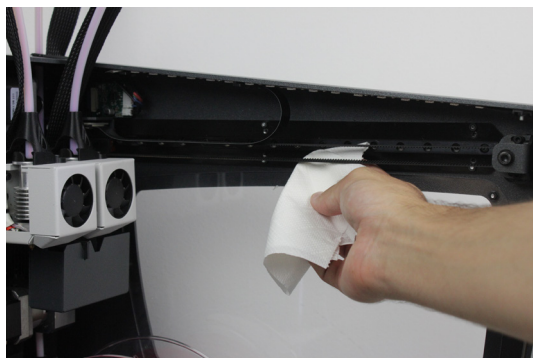

**11.** Apply the lubricating oil pencil along the linear guides of the X and Y axes, with special emphasis on their superior and inferior faces. Make sure there is no excess oil dripping.



# Operation and maintenance

## Hotend Cleaning

It is recommended to clean the hotend periodically and, especially, every time you switch materials. Ideally, use a piece of nylon filament to perform this operation.

1. Operating the printer via the LCD screen, go to *Utilities --> Maintenance --> Hotend cleaning assistant*.
2. Select the hotend to clean and, in case there's material loaded, press NEXT. Otherwise, select SKIP.

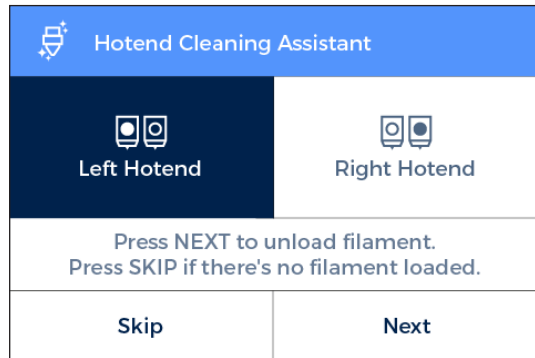
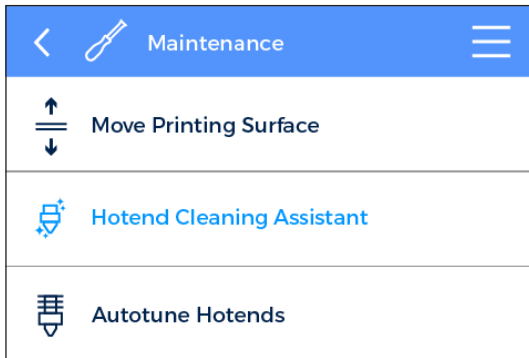

3. Before removing the top teflon tube it will be necessary to remove the black piece and the black clip. Then remove the top teflon tube by holding down the cupling collet and pulling out the tube.

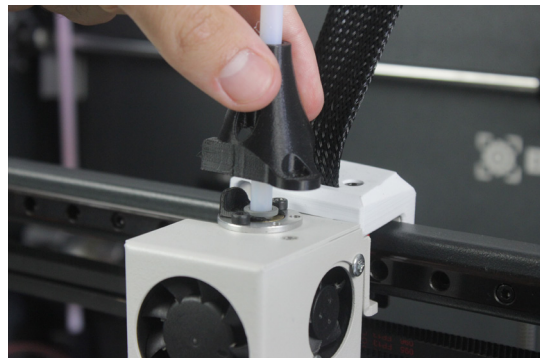



## Operation and maintenance

4. Wait until the hotend heats up.

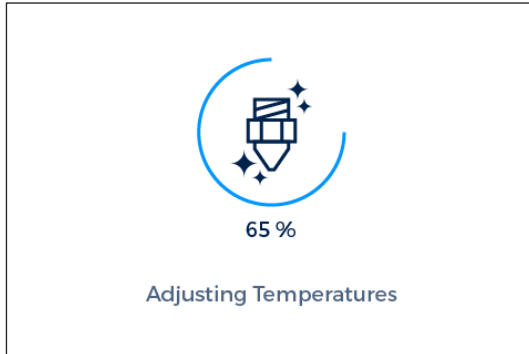

5. Push the nylon filament through the hotend until it comes out clean of residues.

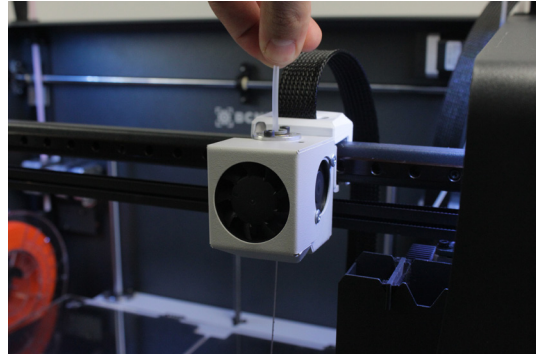

6. Press NEXT and keep pushing until new notice.

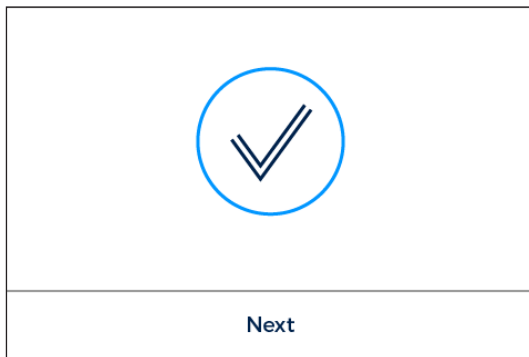

7. Wait while the hotend cools down.

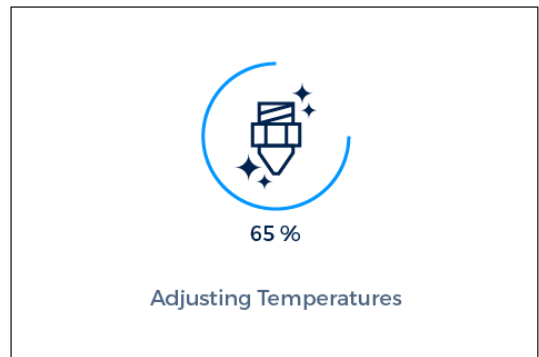

8. Finally, when indicated in the screen, pull out the piece of filament.



9. Repeat the process until the removed filament tip comes out clean. Once it is clean, remember to put back the teflon tube, the black clip and the black piece.

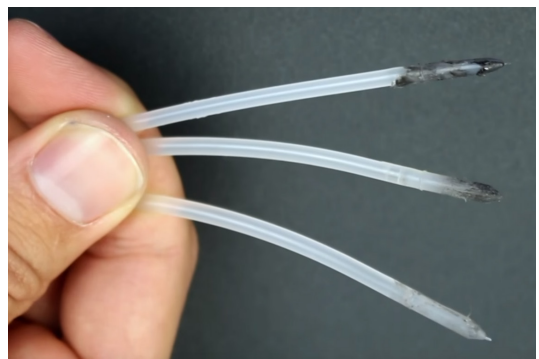

# Filament

The Sigmax R19 printer gives the best printing results when printing with BCN3D Filaments, although it accepts many other materials from other manufacturers.

BCN3D Filaments are industrial-grade materials designed to deliver outstanding results for BCN3D printers. BCN3D Filaments, formulated to ensure the highest print quality, are common polymers in several industries and cover the majority of the technical applications. Those filaments are: PLA, ABS, Nylon, PET-G, PVA, TPU and Composites. Visit our dedicated website for detailed information about each one. Furthermore, you will find the Technical and Safety Datasheets of all of them.

<https://www.bcn3dtechnologies.com/en/3d-printer/filaments/>

A brief description of those materials is given below:

## PLA

PLA (Polylactic Acid) is a biodegradable, sustainable and food safe polymer made from organic sources.

It is the most common used filament in FFF 3D printers for its ease of use and wide range of applications, specially those not mechanically or thermally demanding. Definitely a good starting point to learn about the 3D Printing manufacturing process.

PLA is compatible with PVA supports.

Once printed, PLA parts can withstand operating temperatures up to 50°C.

To ensure good bed adhesion use 3DLac, Dimafix or Glue Stick.

Printing overhangs is easier if the layer fan is used.

It has average mechanical properties, although it becomes slightly brittle when printing irregularly-shaped objects. At operating temperatures of 50° C or more, the mechanical properties and rigidity of the objects may decrease.

## ABS

ABS (Acrylonitrile Butadiene Styrene) is one of the most common technical materials in several industries around the globe. Its great mechanical and thermal behavior make ABS the ideal polymer for countless applications.

Traditionally a challenging material to print with FFF printers, it has been re-formulated to ensure good interlayer adhesion and to reduce warping. Printing with ABS is more complex, and requires a certain amount of care: it is not recommended for non-experienced users.

Once printed, ABS parts withstand operating temperatures up to 85° C.

To ensure good bed adhesion use Dimafix.

Do not use layer cooling fans and avoid drafty or cool rooms for best results.

For a better print quality use the BCN3D enclosure for the Sigmax.

# Filament

## PVA

PVA (Polyvinyl alcohol) is a water-soluble polymer, ideal to work as support material for multi-material 3D Printing.

Optimized for the FFF manufacturing process, our PVA works seamlessly with PLA, TPU, PET-G and Nylon, becoming a reliable universal support material to print complex geometries, large overhangs or intricate cavities.

PVA supports allow to achieve better surface quality, to orientate the part to get better mechanical properties and even to print multi-component models and mechanisms.

To ensure good bed adhesion use 3DLac, Dimafix or Glue Stick.

## PET-G

PET-G (Polyethylene terephthalate glycol-modified) is a globally used co-polyester, from plastic water bottles to cloth fibers and it is 100% recyclable.

As a technical material, PET-G provides good mechanical properties and improved chemical and thermal behaviors than PLA but with similar ease of use.

It has an outstanding chemical resistance, a great dimensional stability and toughness and a good glossy surface quality. PET-G also offers a good abrasion resistance, a high humidity resistance and it withstand operating temperatures up to 70°C. It is compatible with PVA supports.

To ensure good bed adhesion use 3DLac, Dimafix or Glue Stick.

For a better print quality use the BCN3D enclosure for the Sigmax.

## Nylon

Nylon (polyamide) is an extensively used material for its unique mechanical and chemical properties.

Thanks to characteristics like durability, flexibility and resistance to corrosion, Nylon is ideal for multiple applications in the 3D printing field, like end-use parts or custom jigs and fixtures. It is compatible with PVA supports.

Once printed, nylon parts can withstand operating temperatures up to 50°C.

To ensure good bed adhesion use Dimafix or Glue Stick. For a better print quality use the BCN3D enclosure for the Sigmax.

## TPU

TPU (Thermoplastic Polyurethane) is a versatile rubber-like flexible material.

With Shore-A hardness of 95, TPU is a resistant material for several industrial applications, both mechanical or chemical. Moreover, it's been especially designed to improve the 3D printing experience.

Once printed, TPU parts withstand operating temperatures up to 60°C

To ensure good bed adhesion use 3DLac, Dimafix or Glue Stick.

## Composites

Composites are materials with a polymeric base infused with other particles or fibers in different proportion. From wood to metal particles to achieve an aesthetic and attractive finish to carbon fibers to combine lightness and mechanical performance, composite materials for FFF printers unleash creativity.

# Filament

## General considerations

To ensure good adhesion between the printing surface and the 3D printed part, you will need to use an adhesive product that will be applied to the printing surface before start printing. For general materials, we recommend using the glue stick included with the printer or a generic lacquer. If your printed part has adhesion problems with the glass printing surface, we recommend using alternative adhesives, such as 3DLac or Dimafix. Dimafix is ideal for technical materials or complex prints. You can find them on our website <https://www.bcn3dtechnologies.com/en/3d-printer-spare-parts/>

We recommend using an enclosure when printing with technical materials such as ABS, Nylon or PET-G. It provides a constant interior temperature to prevent warping and protects your working environment from potentially harmful particles thanks to the HEPA filter. More information at our website.

Nylon and PVA plastic are hygroscopic, that means it readily absorbs water from the air. Make sure they are dry before printing. Place them in an oven or in a dehydrator at 50 °C for 6 to 8 hours. After drying, store it in an airtight container with desiccant.

# Maintenance Plan

We recommend you carry out the maintenance procedures described in the table below in order to keep your printer running optimally. The procedures are grouped depending on frequency they should be performed is shown on the right.

<b>FREQUENCY</b>	<b>ACTION TO PERFORM</b>
<b>Daily</b>	Keep the printer free of dust and in a dry, cool place
	Store the spools in a dry, cool place
	Remove the filament inside the Purge Tank
	Remove the filament leftovers spread inside the printer
<b>Weekly</b>	Clean the glass printing surface with warm water and soap
	Clean the nozzles
	Level the printing surface glass (also after a transportation)
<b>Monthly</b>	Clean fans dust
	Printer calibration (also after a transportation or replacing a hotend)
	Check firmware updates
<b>Quarterly</b>	Check bolted and threaded joints
	Clean and ubricate axes
	Check tension of extruder springs
	Check X/Y belt tension
	Check connections of moving cables

# BCN3D Technologies

## Technical Assistance Services

If you do not find a solution to your problem in this manual, please contact the BCN3D Technologies team through any of the following channels:

### Technical Assistance

You can contact the technical assistance services by email, and we will answer you as quickly as possible. Please remember to include your phone number so we can contact you.

[support@bcn3dtechnologies.com](mailto:support@bcn3dtechnologies.com)

### Email

If you have a question that is not related to technical assistance, please send us an email to the address below. A BCN3D Technologies expert will contact you as quickly as possible.

[info@bcn3dtechnologies.com](mailto:info@bcn3dtechnologies.com)

You can find all of this information in the Contact Section of our website:

[www.bcn3dtechnologies.com/en/sigma-max-contact](http://www.bcn3dtechnologies.com/en/sigma-max-contact)

Be sure to include the serial number of your printer whenever you send us a query to help us provide the best possible services.

# Diagram of Sigmax R19

- |                          |                             |
|--------------------------|-----------------------------|
| 1 Teflon tube            | 10 Filament entry           |
| 2 Extruder               | 11 Filament Spool           |
| 3 Hotend cable           | 12 Switch                   |
| 4 Spool holder           | 13 Platform                 |
| 5 0.6 mm Hotend          | 14 Power plug               |
| 6 Purge Tank             | 15 USB port                 |
| 7 Glass printing surface | 16 External feeding support |
| 8 SD Card reader         | 17 External feeding guide   |
| 9 Touchscreen            | 18 Filament Runout Sensor   |

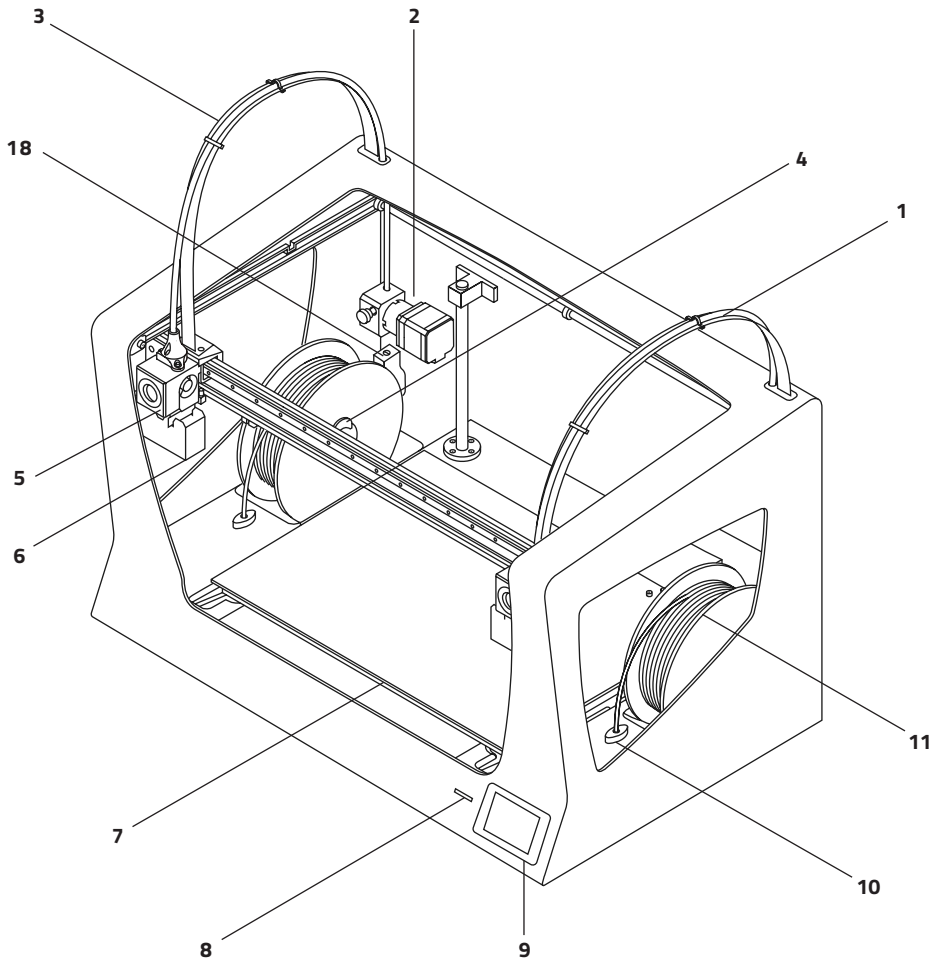

# Diagram of Sigmax R19

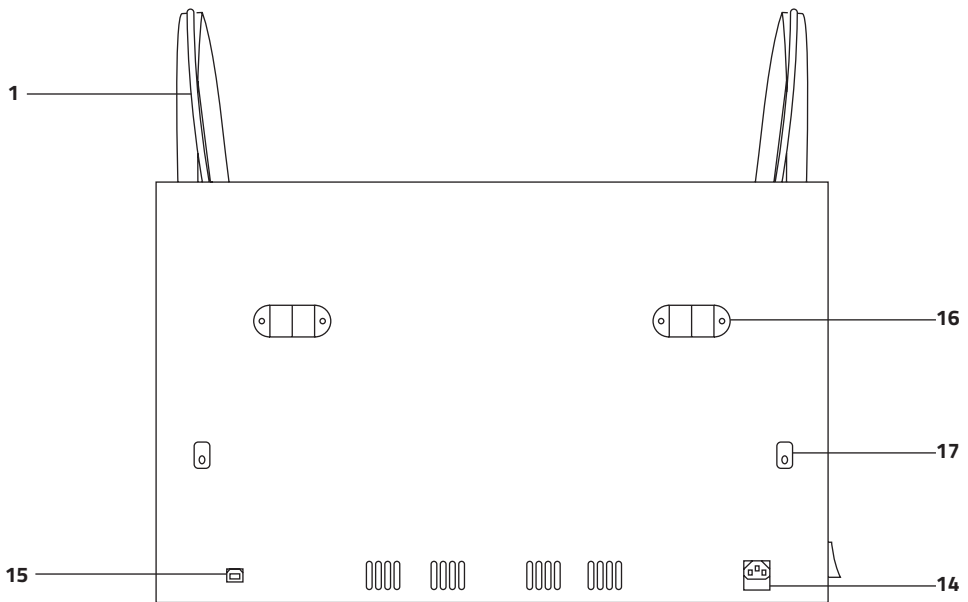
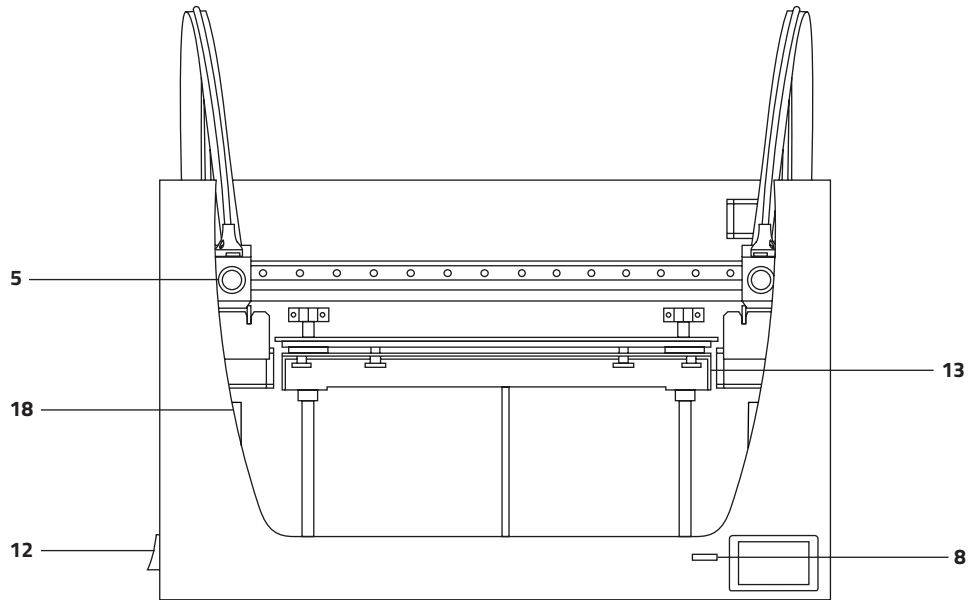



# Terms and conditions

## Overall Vision

The terms “we”, “us” and “our” refer to BCN3D Technologies. The terms “you” and “your” refer to the person or entities that purchase any service or product. BCN3D Technologies offers all the information about products, tools, and services available, always conditioned to the acceptance of all the terms, conditions, policies and notices that are specified below.

By purchasing one of our products, you will be accepting our terms and conditions, including the additional terms and conditions and the policies mentioned in this document.

## Return policy

BCN3D accepts returns for refunds or exchanges, subject to the following:

### 1 Withdrawal right

You have 14 days from the date of reception of the product to execute the right of withdrawal. In order to request a return, the product must not have been opened, it should be closed and sealed inside its original box. If you have opened the product, it will not be eligible for a refund.

This said, the transport costs (both shipping and return, in addition to possible customs fees if the merchandise comes from outside the European Union) will be responsible of the customer and deducted from the amount to be returned.

#### Requirements:

- Having acquired the product through **BCN3D Technologies**
- Be within the established deadline, **which is 14 calendar days from the reception** of the order.

### 2 Defective goods

If you detect any defect in the operation of the product, you have 7 working days from the reception of the product to communicate this defect and proceed to its return.

You should contact the sales department by email through [sales@bcn3dtechnologies.com](mailto:sales@bcn3dtechnologies.com) or by phone +34 934 137070, to notify this incident.

In this case, BCN3D Technologies will be responsible for all the transportation costs.

In cases of wear or tear of the product due to causes that are not exclusively of its use, BCN3D Technologies reserves the right to accept or reject the return of the product, in addition to establishing the conditions of such return or substitution of the product.

### 3 The product received has been damaged during transport

The client will have 24 hours to verify and communicate the integrity of all the components of the order and verify that all the pertinent goods are included within the total set of the demanded product. An order will be considered delivered when the delivery receipt is signed by the customer.

Upon receiving the goods, you must ensure the external package is in good conditions and shows no symptoms of having received a blow. If the package has any sign of having received a blow or any other damage, you must reject it, reflecting it on the delivery note of the carrier and notifying the logistics department by email ([logistics@bcn3dtechnologies.com](mailto:logistics@bcn3dtechnologies.com)) during the following 24h.

## Terms and conditions

### How to make a return?

In order to make a return first, you will have to contact us to [sales@bcn3dtechnologies.com](mailto:sales@bcn3dtechnologies.com), explaining the reason of your willingness to return or substitute one or more products.

- You will receive a document by email to be completed (RMA), so that we can authorize the return.
- Once the RMA is completed, you must send it to [sales@bcn3dtechnologies.com](mailto:sales@bcn3dtechnologies.com) duly completed.
- The after-sales department will assess the situation and within 48 hours will tell you whether or not we accept your return request. If accepted, it will assign you an RMA number with a validity of 30 days.
- The product must be sealed in its **original packaging**. In the case of not returning the order in its original and sealed packaging, BCN3D Technologies reserves the right to accept or reject the return or establish a depreciation of the product.
- Once the product has been packed, we will send a transporter that will pick up the goods to be returned perfectly packed, being able to desist from the collection in case of improper packing. It is important that you place the **RMA number visible on the package**.
- You will not have to pay anything to the courier, except if the withdrawal right is applied (first case), where the cost of the carriage will be deducted from the amount to be returned; or in case the damages produced in the products are not caused by the transport or are not a manufacture defect. In all these scenarios the customer will be responsible for the shipping costs.
- Once the goods are received in our facilities, our technical service will inspect them and determine whether the return is accepted or not.
- The refunds will be carry out between the 1st and 10th of the month according the return acceptance. For example, if the return becomes effective on April 15, the money will be paid between May 1 and May 10.
- In case of not accepting the return for damages produced outside BCN3D Technologies responsibility, you will be given the option to repair the product or return it as it is. Both the repair and shipping will be borne by the customer.

# Open source

Open source is a development model that promotes universal access by granting software licenses free of charge, and also universal distribution, including subsequent improvements.

We believe that adopting an open source philosophy offers many advantages:

- **More control:** We can see everything that is happening with the source code, designs etc., and modify them to suit our needs.
- **It helps us learn:** We can see and read the software designs that other people have made, which helps us to become better programmers and engineers.
- **Safety:** Since the designs are open designs, a lot more people can modify and/or correct any errors that the original programmer may have made.
- **Making improvements quickly:** The open source community provides a lot of information about how to improve the product. This helps us to fix errors and update programmes much more quickly.

Using open source licenses for the products we develop is a way of expressing our willingness to share, to collaborate with other people in a transparent way (so that others can see what we are doing and join in), to embrace failure as a means of improving, and to expect, even encourage, everyone else to do the same.

BCN3D Technologies and its products would not be where they are today without the RepRap project and its open source community. The RepRap project started out as an initiative whose objective was to develop a 3D printer which could print most of its own components and be a low-cost printer. As an open source project, all of the designs produced by the project have been released under a free software General Public License (GPL).

This project does not only include hardware, but has been conceived as a complete ecosystem of tools for printing, from the CAD/CAM software to the code read by the machine to print physical objects.

Sigmax R19 printers use many open source tools and technologies, such as Marlin software and the Cura pre-processed software. The first controls all the printer's components, while the second converts the 3D file into G-code, a language the machine is able to understand.

Marlin firmware is published under a GPL license. This means that we must keep Marlin open, and must provide our source code to end users. For this reason we have our repository on the Github platform, where we post all the changes we make.

Cura software is published under an AGPLv3 license. This is the same as the GPLv3 general license but a paragraph has been added to Section 13 which makes it obligatory to provide source code to those who use software through a network. We therefore have repositories for each operating system so that users can access the source code.

Open Source is not only used for code, but also covers hardware. In our case all the mechanical and electronic parts are published under a GPLv3 license.

BCN3D Technologies is firmly committed to open source initiatives, and we believe that with the help of the community we will be able to make better products.

